



MWA Software

IBX for Lazarus User Guide

Issue 1.14,
3 June 2024

McCallum Whyman Associates Ltd

Email: info@mccallumwhyman.com, <http://www.mccallumwhyman.com>

Registered in England Registration No. 2624328

COPYRIGHT

The copyright in this work is vested in McCallum Whyman Associates Ltd. The contents of the document may be freely distributed and copied provided the source is correctly identified as this document.

© Copyright McCallum Whyman Associates Ltd (2016 to 2024)

trading as MWA Software.

Disclaimer

Although our best efforts have been made to ensure that the information contained within is up-to-date and accurate, no warranty whatsoever is offered as to its correctness and readers are responsible for ensuring through testing or any other appropriate procedures that the information provided is correct and appropriate for the purpose for which it is used.

CONTENTS	Page
1 INTRODUCTION.....	1
1.1 REFERENCES.....	2
1.2 CHANGE HISTORY.....	2
1.2.1 Version 1.1.....	2
1.2.2 Version 1.2.....	2
1.2.3 Version 1.3.....	2
1.2.4 Version 1.4.....	3
1.2.5 Version 1.5.....	3
1.2.6 Version 1.6.....	4
1.2.7 Version 1.7.....	4
1.2.8 Version 1.8.....	4
1.2.9 Version 1.9.....	5
1.2.10 Version 1.10.....	5
1.2.11 Version 1.11.....	5
1.2.12 Version 1.12.....	5
1.2.13 Version 1.13.....	5
2 INSTALLATION AND PREPARATION FOR USE.....	7
2.1 MINIMUM REQUIREMENTS.....	7
2.2 INSTALLATION UNDER LAZARUS.....	7
2.3 CONSOLE MODE IBX.....	8
2.4 MULTI-THREADING SUPPORT.....	8
2.5 INSTALLING FIREBIRD.....	9
2.6 UPGRADING FROM IBX 1.x.....	9
2.7 NEW FEATURES WITH IBX2.....	11
2.8 UNINSTALLING IBX.....	11
3 AN INTRODUCTION TO DATABASES, SQL AND FIREBIRD.....	13
3.1 WHAT IS A DATABASE?.....	13
3.1.1 <i>In the Beginning</i>	13
3.1.2 <i>The Arrival of Random Access Storage</i>	14
3.1.3 <i>Indexes</i>	14
3.1.4 <i>Multiple Indexes and Datasets</i>	14
3.1.5 <i>The Need for Middleware</i>	15
3.1.6 <i>Enter the RDBMS</i>	15
3.1.7 <i>Multi-user Access</i>	15
3.2 THE STRUCTURED QUERY LANGUAGE (SQL).....	16
3.3 THE FIREBIRD RDBMS.....	17
3.4 AND THEN THERE WAS IBX.....	18
4 IBX OVERVIEW.....	21
4.1 CONVERSION FROM DELPHI IBX.....	21
4.2 IBX IN CONTEXT.....	22
4.3 IBX LAZARUS PACKAGES.....	22
4.4 COMPONENT OVERVIEW.....	23
4.5 DATABASES AND TRANSACTIONS.....	26
4.6 DATASETS.....	27
4.6.1 <i>Datasets and Transactions</i>	27
4.6.2 <i>Single Table Datasets</i>	28
4.6.3 <i>SQL Defined Datasets</i>	28
4.7 EXAMPLES.....	29
5 THE DATABASE ACCESS COMPONENTS.....	31
5.1 TIBDATABASE.....	31
5.1.1 <i>Highlighted Properties</i>	31
5.1.2 <i>DatabaseName Macros</i>	33
5.1.3 <i>Parameter Keywords</i>	34
5.1.4 <i>Highlighted Events</i>	34
5.1.5 <i>Connecting to a Database</i>	35
5.1.6 <i>Database Disconnect</i>	35

5.1.7	Reconnecting.....	35
5.1.8	Creating a new Database.....	36
5.1.9	Dropping a Database.....	36
5.1.10	Using the Attachment Interface.....	36
5.1.11	Using the AllowStreamConnected Property.....	37
5.1.12	Using a Firebird DLL or Shared Object Library in a non-default Location.....	37
5.2	TIBTRANSACTION.....	38
5.2.1	Highlighted Properties.....	38
5.2.2	Events.....	39
5.2.3	Transactions and Databases.....	39
5.2.4	Starting a Transaction.....	39
5.2.5	Transaction Parameters.....	40
5.2.6	The Transaction Editor.....	42
5.2.7	Closing a Transaction.....	42
5.2.8	Retaining Transaction State after Closure.....	43
5.3	TIBEVENT.....	43
5.3.1	Highlighted Properties.....	43
5.3.2	Events.....	43
5.3.3	Using Events.....	43
5.4	TIBSQL.....	44
5.4.1	Highlighted Published Properties.....	44
5.4.2	Using TIBSQL.....	45
5.4.2.1	Executing a Stored Procedure.....	45
5.4.2.2	A Stored Procedure that returns Output.....	45
5.4.2.3	Executing a Select Statement.....	46
5.4.2.4	Batched Queries.....	46
5.4.3	The TIBSQL SQL Property Editor.....	47
5.4.4	Scrollable Cursors.....	49
6	THE DATASET COMPONENTS.....	51
6.1	IBX DATASETS.....	51
6.2	COMMON CONCEPTS.....	52
6.2.1	Common Properties.....	52
6.2.2	Common Events.....	53
6.2.3	Exception Handling.....	55
6.2.4	Character Sets and Code Pages.....	55
6.3	TIBTABLE.....	55
6.3.1	Highlighted Properties.....	55
6.3.2	Using TIBTable.....	56
6.3.2.1	Master/Detail Tables.....	56
6.3.2.2	Filtered Datasets.....	57
6.4	TIBSTOREDPROC.....	58
6.4.1	Highlighted Properties.....	58
6.4.2	Using TIBStoredProc.....	59
6.5	TIBQUERY.....	60
6.5.1	Highlighted Properties.....	60
6.5.2	Using TIBQuery.....	61
6.5.3	The Select SQL Property Editor.....	61
6.5.4	Parameterised Queries.....	63
6.5.5	Filters.....	64
6.6	UPDATE OBJECTS.....	64
6.6.1	TIBUpdateSQL.....	64
6.6.1.1	Highlighted Properties.....	65
6.6.1.2	SQL Syntax for Update Object Queries.....	65
6.6.1.3	OLD and NEW Parameters.....	66
6.6.1.4	Insert and Update Returning Clauses.....	67
6.6.1.5	Delete Returning Clauses.....	67
6.6.1.6	Using Stored Procedures for Insert, Update or Delete.....	68
6.6.2	TIBUpdate.....	68
6.6.2.1	Highlighted Properties.....	68
6.6.3	Generators.....	69
6.6.4	Updating Datasets.....	69

6.6.5	<i>Automatic Posting</i>	70
6.6.6	<i>The OnValidatePost Event</i>	70
6.6.7	<i>Cached Updates</i>	71
6.6.7.1	<i>Cached Updates using OnUpdateRecord</i>	71
6.6.7.2	<i>The OnUpdateError Event</i>	72
6.6.8	<i>Identity Columns</i>	72
6.6.9	<i>Row Refresh</i>	73
6.7	TIBDATASET	74
6.7.1	<i>Highlighted Properties</i>	74
6.8	DATASET FIELDS	75
6.8.1	<i>FieldDefs</i>	75
6.8.2	<i>Field Subclasses</i>	76
6.8.3	<i>IBX Fields</i>	77
6.8.3.1	<i>TIBBCDField, TIBSmallIntField, TIBIntegerField and TIBLargeIntField</i>	77
6.8.3.2	<i>TIBStringField</i>	77
6.8.3.3	<i>TIBMemoField</i>	77
6.8.3.4	<i>TIBArrayField</i>	78
6.8.3.5	<i>TIBDateTimeField</i>	78
6.8.3.6	<i>TIBTimeField</i>	79
6.9	QUERY STATISTICS	79
6.9.1	<i>Select Query Statistics</i>	79
6.9.2	<i>Insert, Update and Delete Query Statistics</i>	80
6.9.3	<i>GetRowsAffected for Select Queries</i>	80
6.10	USER PERMISSIONS	80
7	IBX SUPPORT COMPONENTS	83
7.1	THE IBX SCRIPT ENGINE	83
7.1.1	<i>Properties</i>	84
7.1.2	<i>Events</i>	85
7.1.3	<i>Usage</i>	85
7.1.4	<i>Processing a Create Database Statement</i>	85
7.1.5	<i>Examples</i>	86
7.1.5.1	<i>The Script Engine Example</i>	86
7.1.6	<i>The fbsql Console Mode Application</i>	87
7.2	THE DATA OUTPUT FORMATTERS	89
7.2.1	<i>Usage</i>	89
7.2.2	<i>Properties</i>	90
7.2.3	<i>Events</i>	91
7.3	THE SQL PARSER	91
7.3.1	<i>The Parser</i>	92
7.3.2	<i>Use with IBControls</i>	93
7.3.3	<i>Example</i>	93
7.3.4	<i>TSelectSQLParser Reference</i>	94
7.4	ISQL MONITOR	95
7.4.1	<i>TIBISQLMonitor</i>	95
7.4.1.1	<i>Selecting what to monitor</i>	95
7.4.1.2	<i>SQL Reports</i>	95
7.4.1.3	<i>Application Monitoring</i>	95
7.4.2	<i>Examples</i>	96
7.4.2.1	<i>Integrated Monitoring</i>	96
7.4.2.2	<i>Remote Monitoring</i>	96
7.5	TIBDATABASEINFO	96
7.5.1	<i>Per Table Counts</i>	98
7.6	TIBEXTRACT	98
7.6.1	<i>Properties</i>	98
7.6.2	<i>Usage</i>	99
7.6.3	<i>Listing Database Objects</i>	102
7.6.4	<i>Extract of Binary Blobs</i>	102
7.6.5	<i>Extract of Array Data</i>	103
7.7	TIBJOURNAL	104
7.7.1	<i>Properties</i>	104
7.7.2	<i>Events</i>	104

7.7.3 Usage.....	105
7.7.4 Playback.....	105
7.7.4.1 Generators.....	105
7.7.5 Playback in a Client Program.....	105
8 USING FIREBIRD BLOBS.....	107
8.1 BLOB TYPES.....	107
8.1.1 Text Mode Blobs.....	107
8.1.2 Binary Blobs.....	108
8.2 STREAM MODE ACCESS TO BLOBS.....	108
9 USING FIREBIRD ARRAYS.....	109
9.1 DEFINING AN ARRAY ELEMENT.....	109
9.2 TIBARRAYFIELD.....	110
10 USING FIREBIRD SERVICES.....	111
10.1 INTRODUCING THE NEW IBX SERVICES COMPONENTS.....	111
10.2 FIREBIRD ADMIN COMPONENT OVERVIEW.....	112
10.3 COMMON CONCEPTS.....	113
10.3.1 Common Reporting and Event Handling.....	114
10.4 THE TIBXSERVICESCONNECTION.....	114
10.4.1 Properties.....	114
10.4.2 Event handling.....	116
10.4.3 Connecting to the Services Manager.....	116
10.5 THE BACKUP SERVICE.....	117
10.5.1 Server Side Backup.....	118
10.5.2 Client Side Backup.....	118
10.6 THE RESTORE SERVICE.....	118
10.6.1 Server Side Restores.....	119
10.6.2 Client Side Restores.....	119
10.7 THE CONFIGURATION SERVICES.....	119
10.8 THE SERVER PROPERTIES SERVICE.....	120
10.9 THE LOG SERVICE.....	121
10.10 THE DATABASE STATISTICS SERVICES.....	121
10.11 THE SECURITY SERVICE.....	122
10.11.1 Listing all User Names.....	123
10.11.2 Adding a User.....	123
10.11.3 Updating User Details.....	124
10.11.4 Deleting a User.....	124
10.11.5 Setting the Auto Admin State.....	124
10.12 THE USER LIST DATASET.....	124
10.13 THE VALIDATION SERVICE.....	125
10.14 THE ONLINE VALIDATION SERVICE.....	127
10.14.1 Properties.....	127
10.15 THE LIMBO TRANSACTION RESOLUTION SERVICE.....	127
10.15.1 Listing the In Limbo Transactions.....	128
10.15.2 Fixing the In Limbo Transactions.....	129
10.16 THE LIMBO TRANSACTION LIST DATASET.....	129
11 PERSONAL DATABASES.....	133
11.1 TIBLOCALDBSUPPORT.....	133
11.1.1 Properties.....	134
11.1.2 Events.....	135
11.1.3 Shared Data Directory.....	135
11.1.4 DatabaseName, and login parameters management.....	136
11.1.5 Database Initialisation.....	136
11.1.6 Saving the Current Database.....	137
11.1.7 Restoring the Database from an Archive.....	137
11.1.8 Database Schema Upgrade.....	137
11.2 LOCAL EMPLOYEEDB EXAMPLE.....	139
11.2.1 Running the application.....	139
11.2.2 Console Mode.....	139

12 THE IBX CONTROLS.....	141
12.1 TIBDYNAMICGRID.....	142
12.1.1 Column Properties.....	144
12.1.2 TIBDynamicGrid New Properties.....	145
12.1.3 TIBDynamicGrid new Events.....	146
12.1.4 The Editor Panel.....	146
12.1.5 Setting Query Parameters.....	147
12.2 TDBCONTROLGRID.....	148
12.2.1 TDBControlGrid Properties.....	149
12.2.2 TDBControlGrid Events.....	149
12.3 TIBTREEVIEW.....	150
12.3.1 TIBTreeView Properties.....	150
12.3.2 TIBTreeView Methods.....	151
12.3.3 Drag and Drop.....	152
12.3.4 Setting Query Parameters.....	152
12.4 TIBLOOKUPCOMBOEDITBOX.....	153
12.4.1 TIBLookupComboEditBox Example.....	153
12.4.1.1 Auto-insert.....	154
12.4.2 TIBLookupComboEditBox Properties.....	155
12.4.3 TIBLookupComboEditBox Event Handlers.....	156
12.4.4 Setting Query Parameters.....	156
12.5 TIBARRAYGRID.....	156
12.5.1 Properties.....	157
12.5.2 Examples.....	158
12.5.2.1 Database Creation.....	158
12.5.2.2 1D Array Example.....	158
12.5.3 2D Array Example.....	159
APPENDIX A. THE LEGACY IBX SERVICES COMPONENTS.....	161
A.1 FIREBIRD LEGACY ADMIN COMPONENT OVERVIEW.....	161
A.2 COMMON SERVICE PROPERTIES.....	162
A.3 THE BACKUP SERVICE.....	163
A.3.1 Server Side Backup.....	163
A.3.2 Client Side Backup.....	164
A.4 THE RESTORE SERVICE.....	164
A.4.1 Server Side Restores.....	165
A.4.2 Client Side Restores.....	165
A.5 THE CONFIGURATION SERVICES.....	165
A.6 THE SERVER PROPERTIES SERVICE.....	166
A.7 THE LOG SERVICE.....	167
A.8 THE DATABASE STATISTICS SERVICES.....	167
A.9 THE SECURITY SERVICE.....	168
A.9.1 Listing all User Names.....	168
A.9.2 Adding a User.....	168
A.9.3 Updating User Details.....	169
A.9.4 Deleting a User.....	169
A.10 THE VALIDATION SERVICE.....	170
A.10.1 Database Repair.....	170
12.5.4 Resolving Limbo Transactions.....	171
A.11 THE ONLINE VALIDATION SERVICE.....	172
A.11.1 Properties.....	172
A.11.2 Usage.....	173
APPENDIX B. IBX BUFFER MANAGEMENT.....	175
B.1 TDATASET.....	175
B.1.1 TDATASET BUFFERS.....	175
B.1.2 BUFFER POOL INITIALISATION.....	176
B.1.3 BUFFER POOL DESTRUCTION.....	176
B.1.4 SCROLLING THROUGH A DATASET.....	176
B.1.5 ROW EDITING.....	177
B.1.6 ROW DELETION.....	177

B.1.7	ROW INSERT/APPEND.....	177
B.1.8	ACCESSING FIELDS.....	178
B.1.9	CALCULATED FIELDS.....	178
B.1.10	BLOB SUPPORT.....	178
B.2	LEGACY IBX.....	178
B.3	IBX: IMPROVED BUFFER MANAGEMENT.....	179
	<i>B.3.1 The Display Buffer</i>	179
	B.3.2 THE BUFFER CACHE.....	179
B.4	IMPLEMENTATION.....	180

1

Introduction

The *IBX for Lazarus* Guide is a guide to the IBX fork created by MWA Software for Lazarus.

IBX for Lazarus is derived from the Open Source edition of IBX published by Borland/Inprise in 2000 under the InterBase Public License. In 2011, the Open Source edition of IBX was brought up-to-date by MWA Software (<http://www.mwasoftware.co.uk>) and focused on the Firebird Database API for both Linux and Windows platforms (32 and 64-bit), and has since been further developed. It is released under the InterBase Public License for the original code and under the compatible Initial Developers Public License for new software. The Firebird Relational Database Management System can be downloaded from <http://www.firebirdsql.org>.

While the core of the product remains the original IBX software, this version includes a completely new set of property editors supporting SQL generation and testing using the Firebird Database engine direct from the IDE. These are intended to be a significant improvement on the Delphi Property Editors. IBSQLMonitor has also been re-organised in order to isolate the platform dependent aspects, allowing for the use of SV5 IPC for the Linux environment. The original Windows IPC is retained for the Windows environment. IBEvents has also been updated to ensure compatibility with Firebird Events.

Support for generators has also been added compatible with the generator support added to IBX after the Open Source edition was published, supporting both “On New Record” and “On Post” generators. There are also many new data aware controls distributed as part of the package, plus a scripting engine. TIBExtract has also been brought up-to-date.

From version 2 onwards, IBX uses the *fbintf* package to use either the new Firebird 3 API or the legacy Firebird API. The *fbintf* package is partly derived from IBX and automatically loads the Firebird 3 API, if available, the legacy API if not. *fbintf* is distributed with IBX. The Firebird Pascal API Guide provided with the *fbintf* package provides important information on the installation for the Firebird Server for development system and guidelines for deployment.

See also the Firebird Pascal API Guide for information on:

- Using the API interfaces exposed by IBX
- Character sets and their relation to AnsiString Code Pages
- Deployment of applications using the Firebird Client library.

This Guide assumes that the reader has a basic knowledge of the Lazarus Integrated Development Environment (IDE). Some knowledge of Firebird and database concepts is desirable. However, a primer on the subject is provided (see chapter 3).

1.1 References

1. InterBase 6 API Guide (<http://www.ibphoenix.com/files/60ApiGuide.zip>)
2. Firebird 2.5 Language Reference (http://firebirdsql.org/file/documentation/reference_manuals/fblangref25-en/html/fblangref25.html)
3. InterBase 6 Data Definition Guide (<http://www.ibphoenix.com/files/60DataDef.zip>)
4. Firebird 3.0.1 Release Notes (http://www.firebirdsql.org/file/documentation/release_notes/html/en/3_0/rlsnotes30.html)
5. IBX for Lazarus (MWA Software – <http://www.mwasoftware.co.uk/ibx>)
6. Firebird Pascal API Guide – MWA Software, 2016-2022

1.2 Change History

1.2.1 Version 1.1

This version has been updated to include:

- Extended TIBExtract functionality for output of data, including the simple XML formats for binary blobs and arrays, and privileges (grants) given to Triggers and Stored Procedures.
- Extended TIBXScript functionality in order to process XML format data exported by TIBExtract and embedded in INSERT Statements.
- Documentation of Data Output Formatters (see 7.2).
- Minor Typos and corrections.

1.2.2 Version 1.2

- Minor typos and corrections

1.2.3 Version 1.3

- Introduces TIBUpdate

1.2.4 Version 1.4

- Removal of ReadOnly as a common property of IBX TDatasets. This was never true.

1.2.5 Version 1.5

- Support for Insert and Update query RETURNING clauses added (see 6.6.1.4)
- Support for Delete query RETURNING clauses added (see 6.6.1.5).
- Support for Firebird 3 Identity Columns added (see 6.6.8).
- A new section on IBX TField subclasses is provided as section 6.8.
- The description of TIBStoredProc has been updated to include support for Firebird 3 Packages (see 6.4).
- A new section on the TIBSQL Property Editor has been added (see 5.4.3).
- A new section on row refresh has been added (see 6.6.9).
- The cached updates section has been improved and now describes the use of OnUpdateRecord and OnUpdateError event handlers (see 6.6.7).
- Missing migration issue added to “Upgrading From Earlier Versions” on additional TIBSQL error checks (See 2.6)
- Text reviewed and corrected for typos and other minor errors.
- Removal of TIBTable FieldDefs as a published property.
- Expected_db parameter added to Services API support (see 10.4).
- Additional Database Information properties and function in support of isc_info_active_tran_count, isc_info_creation_date and fb_info_page_contents request items (see 7.5).
- TIBSecurityService support of Admin Role from Firebird 2.5 onwards (see 10.11).
- TIBBackupService and TIBRestoreService now support additional statistics requests in verbose output mode (See 10.5 and 10.6).
- TIBOnlineValidationService added to Firebird Admin Palette (see 10.14).
- PagesFree and PagesUsed properties added to TIBDatabaseInfo (see 7.5)
- A SetNoLinger method added to the Database Configuration Service (see 10.7).
- ImageIndexField and SelectedImageIndexField properties added to TIBTreeView (see Error: Reference source not found).

1.2.6 Version 1.6

- Chapter 10 updated for new and re-architected Services API components. The previous text of chapter 10 is still available as Appendix A.
- New section added on IBX Lazarus Packages (see 4.3).
- TIBDataSet, TIBQuery and TIBTable can now all return performance statistics (see 6.9).
- AlwaysQuoteIdentifiers property added to TIBExtract (see 7.6.1)
- Clarification at end of introduction to chapter Error: Reference source not found as regards the correct place to set query parameter values when using the IBX Dynamic Controls (see also Error: Reference source not found, Error: Reference source not found and Error: Reference source not found)
- New property MasterDetailDelay added to TIBTable (see 6.3.1) and TIBQuery (see 6.5.1) and TIBDataset (TIBQuery documentation applies to IBDataset).
- Text added describing IBX use in multi-threaded applications (see 2.4).
- TIBExtract updated to include eoPackage in list of extract objects (see 7.6.2)
- TIBExtract. New property CaseSensitiveObjectNames (see 7.6.1).
- TIBExtract: additional Extract Types etDatabaseTriggers and etDDLTrigger (see 7.6.2)
- TIBDatabase.Reconnect added (See 5.1.7).
- TIBExtract: New Property IncludeMetaDataComments (see 7.6.1) and new ExtractObject eoComments (see 7.6.2). New method ListObjectNames added (see 7.6.3).

1.2.7 Version 1.7

- Correction to discussion on thread safety to note that the Firebird API itself has been thread safe from Firebird 2.5 onwards.
- FirebirdLibraryPathName and FirebirdAPI properties added to both TIBDatabase and TIBXServicesConnection. See also 5.1.12.

1.2.8 Version 1.8

- New properties for TIBDatabase and TIBXServicesConnection. These are "ConfigOverrides" and "WireEncryption". See 5.1.1, 5.1.5 and 10.4.1.
- New properties and event for TIBCSVDataOut, TIBInsertStmtsOut and TIBBlockFormatOut. i.e. TimestampFormat, DateFormat, TimeFormat, QuoteStrings, FieldSeparator, HeaderSeparator, and OnFormatTextString.
- A section on how IBX interacts when user privileges has been added (see 6.10).
- New public property "InOnCreateDB" for TIBLocalDBSupport (see 11.1.1).
- Clarification on use of TIBTable Filters added (see 6.3.2.2). TIBQuery (and hence TIBDataSet) support of filtering is described in 6.5.5.

- Clarification added on the processing of a CREATE DATABASE statement by TIBXScript (see 7.1.4).
- TIBDatabase.Attachment and TIBXServicesConnection.ServicesIntf properties are now read/write. This should be enabled (e.g.) multiple instances of TIBDatabase to share the same database connection. See 5.1.10 and 10.4.1.

1.2.9 Version 1.9

- Set Generator now supported by TIBXScript (see 7.1).
- Firebird 4 Data types supported: DecFloat and INT128 (See 6.8.2), Timestamp with Time Zone and Time with Time Zone (see 6.8.3.5)
- IBExtract updated to support new Firebird 4 DDL
- IBExtract now supports internal functions (Firebird 3 extension)
- SQLFiltered and SQLFilterParams properties added to TIBTable (see 6.3.2.2) and TIBQuery/TIBDataset (See 6.5.5).

1.2.10 Version 1.10

- Clarification on manually entered StoredProcNames added (see 6.4)
- Support for Firebird 4.0 Batch Execution Interface (see 5.4.2.4)
- New property in TIBLocalDBSupport - SectionHeaderTemplate (see 11.1.1)

1.2.11 Version 1.11

- Support for scrollable cursors in TIBSQL (Local Database connections only). See 5.4.1 and 5.4.4.

1.2.12 Version 1.12

- TIBTransaction: new properties (see 5.2.1)
 - property TransactionID: integer read GetTransactionID;
 - property IsReadOnly: boolean read GetIsReadOnly;
 - property TransactionName: string read FTransactionName write SetTransactionName;
- TIBDatabaseInfo. New property FirebirdVersion (see 7.5)
- New unit IBJournal (see 7.7).

1.2.13 Version 1.13

- Complete rewrite of internal buffer management in order to improve performance and maintainability (see Appendix B.). The definition of the TDataset.BufferChunks property has changed and new property BufferChunksInFirstBlock introduced (see 6.2.1).

- TIBUpdateSQL: changes to SQL text will close linked dataset if open. This is to ensure same behaviour as TIBDataset, TIBTable and TIBStoredProcedure.
- TDataset.Refresh now complies with the FPC Manual specification. See 6.6.9 for more information and how row refresh is now performed.

1.2.14 Version 1.14

- Chapter 12 (IB Controls) moved to standalone document “DynamicDatabaseControls”.

2

Installation and Preparation for Use

IBX for Lazarus is distributed in a single archive (zip or tar.gz format) and includes the *fbintf* package. You can obtain an up-to-date version from <http://www.mwasoftware.co.uk/ibx>.

The archive should be expanded into some permanent location on your development system alongside the Lazarus IDE. One possible location is to add a directory called “otherComponents” to your Lazarus installation directory and expand the IBX archive into that directory. IBX will then be located under:

“<Lazarus installation directory>/otherComponents/ibx”.

2.1 Minimum Requirements

IBX 2.0.0 requires at least Lazarus version 1.6.0 and version 3.0.0 of the Free Pascal Compiler.

All versions of the Firebird Server are supported including version 3.

The Firebird client library must also be installed. If this client library supports the new Firebird 3 client API then this is used, otherwise IBX uses the older Firebird 2 API.

2.2 Installation under Lazarus

The Firebird Client Library should be installed on the system prior to installing into the Lazarus IDE. The Firebird Pascal API Guide provides guidelines for installing Firebird.

Installation into the Lazarus IDE is the same under both Linux and Windows. Unpack the source code archive into some suitable permanent location, as described above, and open the “dclibx.lpk” package description file using the “Package->Open Package File” menu item to open the file.

When the Package Editor opens, click on “Use->Install”. Lazarus will now recompile itself and restart. THREE new tabs should now be present on the Component Palette: “Firebird”, “Firebird

Admin”, and “Firebird Data Controls”. Respectively, these contain the IBX Database Access and Service API components. A third tab on the palette will contain the “Firebird Data Controls”.

If no IBX components are visible, then the most likely reason is that the Firebird Client Library has not been installed and/or cannot be located. See the Firebird Pascal API Guide for information on how *fbintf* and hence IBX finds the Firebird Client Library.

2.3 Console Mode IBX

IBX can be used as visual components under Lazarus or in console mode programs. Non-LCL programs should use the *ibnongui* package, while LCL programs should use the *ibexpress* package. The *ibexpress* package uses *ibnongui* and adds the LCL dependencies (built in login dialog and hourglass cursor on DB operations).

In previous releases, a separate package was provided for console mode programs, excluding any LCL dependencies, called “*ibexpressconsolemode*”. This is still available as a “stub” package that loads the *ibnongui* and *iblocalnongui* packages.

If you need to continue to use the legacy console mode package in the IDE the you should select “Packages->Open Package File” and open *ibexpressconsolemode.lpk*: which you can find in the *ibx* root directory. You should then close it again immediately afterwards. There is no need to install or compile it. Opening the package is sufficient for Lazarus to remember it.

An example of console mode use is provided in *ibx/examples/fbsql*.

2.4 Multi-threading Support

IBX can be used in a multi-threading application. The underlying Firebird API is has been thread safe from Firebird 2.5. However, either only a single thread should use IBX or you should ensure that only a single thread at any one time is using an IBX provided function.

Internally, IBX makes use of separate threads for:

- SQL Monitoring (see 7.4)
- Waiting for Firebird Asynchronous Events (see 5.3)
- Implementation of the Master/Detail delay time in *TIBTable* (see 6.3.2.1), *TIBQuery* and *TIBDataset* (see 6.5.1).

If your program uses any of the above then it must include multi-threading support. In Windows and OSX, this is always available. However, under Linux it is only available if you include the “*cthreads*” unit as the first unit in your program unit. When an application is created from a Lazarus template, this unit is included by adding “*-dUseCThreads*” to the project's Custom Options.

If multi-threading support is not compiled into your program, then an attempt to use any of the above will result in an *IBError* Exception reporting the need to compile mutli-threading support into your application.

The above functions make use of Thread Synchronization with the *TThread.Synchronize* method. In a non-GUI application, this requires that the main thread makes frequent calls to the “*CheckSynchronization*” procedure (in the *classes* unit). This ensure that the synchronization queue is regularly flushed. In GUI applications this is performed as part of the event loop and hence need not be called within a user's application code..

2.5 Installing Firebird

You need access to a minimum of the Firebird Client library in order to use the *fbintf* package. This applies to both development and deployment. Guidelines for deployment are give in chapter 13 of the Firebird Pascal API Guide.

On a development system, the recommended approach is to download a pre-compiled installation package from <http://www.firebirdsql.org> and install the full system including examples. This will ensure that the example “employee” database is both installed and available for use by the *fbintf* testsuite, and a local server is available for testing. Firebird installation packages are available for both Linux and Windows as well as OSX.

With Linux, it is also possible to use the packages provided with your distribution. However, these will not necessarily be up-to-date. Under Debian/Ubuntu the example database is also provided as a separate package and you will need to install this package as well as unpack the database from a gzip archive and set the access permissions correctly before running the test suite. Paradoxically, unless you are very familiar with Firebird and Linux, it is often easier to install the firebirdsql package than the one from your distro.

After installation, you should check that the “employee” is correctly listed in the “aliases.conf” (databases.conf for Firebird 3) file in the Firebird installation folder. For example, with 32-bit Firebird under Windows, the file

```
C:\Program Files (x86)\Firebird\Firebird_2_5\aliases.conf
```

should contain the line:

```
employee = C:\Program Files (x86)\Firebird\Firebird_2_5\examples\empbuild\employee.fdb
```

2.6 Upgrading from IBX 1.x

There are many differences between the IBX2 files and earlier versions and you should first either remove or rename the directory containing earlier versions of IBX, and then install the new version as described in the preceding section. Applications using IBX should be rebuilt rather than just recompiled (use Run->Clean up and Build from the Lazarus menu).

IBX2 represents a major change in the underlying IBX codebase. The low level “glue” that represented the language binding between the Firebird ‘C’ API and native Pascal has been moved into a new package “fbintf” and communication between IBX and this “glue” is now through a well defined Pascal interface. Two implementations of the interface have been produced. One for the legacy Firebird API and another for the new Firebird 3 API. By default, IBX will use the Firebird 3 API, if available, otherwise it uses the legacy Firebird API.

The core body of IBX has been modified to use this new interface. Full support for Firebird Arrays has also been introduced. However, the emphasis has been on maintaining backwards compatibility as far as possible, even though there have been significant changes in the code base.

When migrating an existing IBX 1.4.x application to IBX 2.0.0 most users will need only to recompile against the upgraded package. However, advanced users may need to make changes due to the following incompatibilities:

1. The IBIntf, IBCodePage and IBXConst units have been removed from the package. Uses clauses that use IBIntf or IBXConst should be replaced with use of the “IB” unit. This is now

part of the *fbintf* package and which provides the Firebird Pascal API including all constants and type definitions associated with it.

IBCodePage was an internal unit providing the mapping between Firebird Character sets and code pages. Equivalent functionality is now provided by the Firebird Pascal API.

2. Any use of the IBHeader unit should be replaced with use of the IB unit. If there is a resulting compile time error after this has been done then, the reason is probably due to a dependency on the legacy Firebird API. IBHeader still exists but it contains the definition of the legacy API and any dependency on it implies a potential problem when IBX uses the new Firebird 3 API. Any such dependency should be identified and replaced with the equivalent functionality provided by the Firebird Pascal API defined in the IB unit.
3. The TIBSQL property SQLType has been renamed to SQLStatementType. The version roll has been taken advantage of to remove a potentially ambiguous property name. The property name is also used by the input and output metadata to define SQL data types.
4. In IBX2, Automatic transaction Start/Commit is no longer the default except at design time. This may affect some simple uses of IBX with a single dataset on a form and no explicit transaction management. A “transaction no active” error will result when a dataset is opened if your application previously relied on this feature.

A new property AllowAutoActivateTransaction (see 5.2.4) has been added to TIBCustomDataset descendents. By default this is false. If set to true then the original behaviour is restored.

The version roll has again been taken advantage of to remove a problematic feature. Autostart of transactions only ever worked properly with single dataset applications. With multiple datasets, the order in which the datasets were closed became important (reverse order to opening assumed). With multiple datasets, the transaction could easily remain open after the datasets were closed relying on the database close to correctly perform a transaction completion.

There could also be problems when explicit transaction start is used, as the programmer needs to make sure that the transaction was started before any datasets were accessed. Otherwise, unexpected results could ensue.

On the other hand, it is a valuable feature at design time, allowing a dataset to be opened and its data displayed in the IDE.

If your application relied upon automatic starting/completion of transactions, the simplest way to restore this behaviour is to set the AllowAutoActivateTransaction property to true.

If your application has more than one dataset on the form then this property need only be set for the first one that is opened (active property set to true). This dataset should also be the last one closed (active set to false).

5. The UniqueParamNames property is now ignored and exists only for backwards compatibility. Parameter name uniqueness is now determined dynamically.
6. TIBSQL error checking is now more strict. In earlier versions, there were no checks for data validity when (e.g.) accessing query results. In IBX2:

- An exception is raised if an attempt is made to access query results before the query has been executed, when the cursor is at BOF or EOF, or after the query has been closed.
- An exception is raised if an attempt is made to set query parameters before a query has been prepared.

2.7 New Features with IBX2

- Firebird 3 API Support
- Access to the Firebird Pascal API for embedded SQL execution.
- IBDatabase: new property - `CreateIfNotExists`. If true and the database does not exist when an attempt is made to connect to it (run time only) then an attempt is made to create the database.
- IBDatabase: new event - `OnCreateDatabase`. This event is called after a database has been successfully created as a result of a call to `CreateDatabase` or when creating a database after it was found not to exist.
- Support for arrays has been added. This includes a new field class (`TIBArrayField`) – see chapter 9 - and a supported visual control derived from `TcustomStringGrid`.

2.8 Uninstalling IBX

To uninstall IBX, open the “dclibx.lpk” package description file using the “Package->Open Package File” menu item to open the file.

When the Package Editor opens, click on “Use->Uninstall”. Lazarus will now recompile itself and restart without the IBX components in the palette. You may now delete the IBX source code.

3

An Introduction to Databases, SQL and Firebird

This chapter is intended to provide a primer on Databases, SQL and Firebird for those not familiar with these subjects. Readers who are familiar with them are invited to proof read this chapter but otherwise, they may prefer to skip to the next chapter.

3.1 What is a Database?

The dictionary definition of a database is that a database is no more than a collection of data. It says nothing about how the data is organised or accessed. Some databases can be just a large amount of unstructured data, while others can be fully structured with strongly enforced rules. It is the latter case that we are interested here, and we will leave the former to Google.

The type of database that Firebird manages, and for which the Structured Query Language (SQL) was written, is structured with well defined rules so that they can be processed in a deterministic fashion with repeatable outcomes. This type of database is well suited to business applications, such as accounting and stock management, Personnel Management and Payroll.

3.1.1 In the Beginning

In the 1960s and through to the 1980s, Magnetic Tape was the dominate storage medium for big company databases (accounting, stock, etc.). Magnetic Tape is a linear medium accessed sequentially. The data is written to it as “records” and usually ordered using some common relation such as account number or a person's name. Each record contains the data for the account or some person's registration details.

Magnetic Tape databases had to be processed sequentially. It could take a long time to find the record you are interested in, as you had to start at the beginning and work forwards, reading through one or more tapes. Data update was equally laborious with the usual technique being to prepare an update tape with update actions in the same order as the database records and the

application of updates was essentially a data merge between the current set of tapes and the update tape resulting in a set of new master tapes.

3.1.2 The Arrival of Random Access Storage

Disk drives started becoming commonplace in the 1970s. Initially they were too expensive to hold complete databases and were used to cache data and to speed up operations. As they become bigger and cheaper, it was possible to start saving entire databases on to magnetic disks.

Magnetic disks can be randomly access. That is any sector on the disk can be accessed in about the same speed as any other. This opened up the possibility of having high speed access to database records and perhaps even *in place* updates. However, there was still the problem of how do you find the record you are interested in? If you still had to start at the beginning and read on until you found the desired record, access would still be slow and variable depending on how far down the data the record was located.

3.1.3 Indexes

The answer was to create indexes, where an index is a comparatively small lookup table or tables that may be randomly accessed and could quickly point you at the record you were interested in.

An index is intended for use with a selected key into the data (such as an account number). In principle an index could be just a table of account numbers (the key into the record) and the sector address (on the disk) where the record is held. The index table could then be searched much more quickly than going through the entire database and give much faster access to the data.

For small databases, a simple lookup table is sufficient. However, for large databases, the overhead of searching an index table is still significant and something better is needed. As a result, Indexes became better structured. Perhaps one table for the first part of an account number and then separate tables for the second part, and selected by lookup of the first part of the account number.

Another approach was to generate a hash value from a record key (e.g. the account number) and use that as a numeric table index to where the (e.g.) account number/record address was located. The development of efficient indexes became an important line of research.

3.1.4 Multiple Indexes and Datasets

Of course, there was no reason why only a single index was the limit. A database could have many indexes on the same data, one for each access key that you could define. Attention also moved to the structure of the database. The terminology started firming up with the database being broken up into smaller datasets, each with their own index; the sum total of datasets and indexes becoming the database. Given that, in this case, the dataset was a list of identically structured records, they could be modelled as "tables", with each record being a table row and the fields of each record forming the columns.

The original Magnetic Tape databases often contained data duplicated across different databases, if only because it was too difficult to organise the simultaneous processing of multiple tapes. When disks became common, there was value in removing duplication between datasets. This both avoided the risk of differences between data describing the same thing and minimised the use of still expensive disk storage.

However, this did mean the creation of many more smaller datasets and their own indexes and the need for the programs that accessed them to have simultaneous access to many datasets and to “join” the data together.

3.1.5 The Need for Middleware

When applications start having to solve common problems there is always an opening for a common middleware solution, and database access was no exception.

Soon many middleware solutions started appearing. Their role was to manage all the different datasets and their indexes and to provide standard ways of joining the datasets and updating the datasets. They freed the client applications from the need to open lots of separate files and instead became a single point of access – the database provider.

3.1.6 Enter the RDBMS

The middleware solutions soon evolved into the kind of Relational Database Management Systems (RDBMSs) that we know today. Although the various products have their differences, they can be said to:

- Manage a database comprising many datasets, where each dataset is viewed as a table of data accessed using one or more indexes.
- Maintain metadata (data about data) that describes each table in the database and each index.
- Provide a single point of access to the database to client applications.
- Allow the data to be accessed by table or by joining tables together, using common keys, to create larger virtual datasets (often called views).
- To provide a means to refine the views by limiting both the number of rows returned and the columns in each row. Thereby improving both efficiency and security (by limiting access to data).
- To provide a means to update rows, insert new rows and delete existing rows, including whole table operations.

Throw in performance optimisation, backup and restore, data redundancy (e.g. shadow databases) and you are starting to get something like the modern RDBMS. Some RDBMS servers still maintain each dataset as a separate file (e.g. some versions of MySQL), while others place the whole database in a single file and organise its contents into many files.

3.1.7 Multi-user Access

The old Magnetic Tape databases were, by their nature, single user access. However, a modern RDBMS can support a large number of concurrent users all reading data and often updating different parts of the database. In turn, this introduces the risk of conflict between different users concurrently reading and writing to the same record.

Simple table or record “locks” are one way around this problem. A user that wants to update a table or an individual record, first locks it, then updates the data and finally unlocks it. If only one user at a time can create a lock this can ensure that a user can lock all related records they need

to update, update them and finally release them, ensuring that data consistency is maintained. Other users can be prevented from updating those records while a lock is placed on them and can even be prevented from reading them. Users can also be made to wait for a lock to be released.

While a basic record lock mechanism can be viewed as essential for concurrent database update, modern RDBMSs usually go a step further and introduce the idea of a transaction.

Under this model of use, each database client connects to the database via a “Connection” (which can be local or remote), and each connection can have multiple transactions active at any one time, where a transaction:

- Has a well defined start and end, while existing for as long as the client needs it.
- Is the context under which all data is accessed and updated.
- “Owns” any necessary table and record locks, dataset cursors and any other resources used by a client.
- Provides “isolation” between concurrent users, in the sense controlling how much they see of changes performed by other transactions.
- When the transaction ends, all changes made during the transaction can either be committed – that is become changes to the database visible to everyone – or rolled back to their state when the transaction started.

Transactions allow each client to have a consistent view of the database, and a means of preventing data inconsistency resulting from conflicting changes.

3.2 The Structured Query Language (SQL)

As discussed above, a basic function of an RDBMS is to provide a means to define and maintain the metadata: the table and index definitions. There is also a need to describe how tables are joined and filtered to create views, both permanent and transient, and for commands to update the database.

This requirement can be satisfied in many different ways. However, SQL has become the *de facto* standard for these tasks. SQL dates back to IBM in the 1970s and provides a means to achieve the above using an English like syntax. It was standardised by ANSI in 1986 and became an international standard in 1987. There was a major update in 1992 (SQL-92) and further minor revisions have taken place since then. While an international standard, each RDBMS has implemented its own variations and hence has its own SQL dialect.

SQL can be split up into:

- The Data Definition Language (DDL), which is used to describe tables, indexes and views i.e. to maintain the database metadata.
- The Data Manipulation Language (DML), which is used to get (select) data from the database, as well as to insert, update and delete data.
- Transaction Management
- Procedure and Trigger Language (PSQL), which is used to define operations on the database that can be requested by a client or which take place automatically when data is changed. In the latter case, this is often used to validate changes.

The following is an example of the DDL, and is an example of defining a database table:

```
CREATE TABLE EMPLOYEE
(
  EMP_NO smallint NOT NULL,
  FIRST_NAME varchar(15) NOT NULL,
  LAST_NAME varchar(20) NOT NULL,
  PHONE_EXT varchar(4),
  HIRE_DATE timestamp DEFAULT CURRENT_TIMESTAMP NOT NULL,
  DEPT_NO char(3) NOT NULL,
  JOB_CODE varchar(5) NOT NULL,
  JOB_GRADE smallint NOT NULL,
  JOB_COUNTRY varchar(15) NOT NULL,
  SALARY numeric(10,2) DEFAULT 0 NOT NULL,
  PRIMARY KEY (EMP_NO)
);
```

The above defines the table as consisting of ten columns. Each column is given a name and a data type. The table's primary key is the employee number (EMP_NO) and this provides a unique identifier for each row.

Note that SQL statements are always case insensitive including column names (although later extensions have allowed for column names that are case sensitive and which may include special characters by enclosing them in double quotes).

The table definition also includes an important concept that has not been discussed so far and that is the concept of the "NULL" value. Unless constrained to be "NOT NULL" as illustrated above, the values in each row of a table column can be either a value in their declared type or have no value (i.e. null). NULL values can be searched for, can be used to select data, and data values can be set to NULL. The Firebird Null Guide provides more information on the use of Nulls.

An example of a Select Statement follows. This creates a temporary virtual dataset which can then be read by the requesting client.

```
Select FIRST_NAME, LAST_NAME, EMP_NO, HIRE_DATE FROM EMPLOYEES
Where LAST_NAME LIKE 'P%';
```

The dataset returned by the above has only four columns and is filtered so that it comprises only the employees whose last name starts with the letter 'P'.

Note: in SQL comparisons, the '%' character means any string.

3.3 The Firebird RDBMS

Firebird is an example of a Relational Database Management System (RDBMS). It is an Open Source product with a permissive licence for use that includes use in commercial applications. It can also require very little, if any, input from a System Manager and hence is well targeted on SME applications. Although it generally scales well to larger applications, as well.

Firebird came about when Borland/Inprise released the InterBase 6.0 software under an Open Source Licence in 2000. InterBase already had a long history (documented on <http://www.firebirdsql.org/en/historical-reference/>) and Firebird inherited a large user community from InterBase.

In its modern instantiation, Firebird:

- is a multi-user, transaction based RDBMS
- uses SQL for Data Definition, Data Manipulation, Transaction Management and Procedure and Trigger Definition.
- Deployed as either an embedded database engine (embedded server) or as a standalone server accessed using TCP/IP supporting both local and remote connections.
- Uses a single file per database (with the option of secondary files to allow for overflow to separate filesystems).
- Implementation packages are available for many platforms including Windows (32 and 64 bit), Linux (32 and 64 bit) and OSX.

Firebird also includes the concept of “Events”. That is asynchronous alerts that are PSQL generated and which can be sent to an interested client. These are typically used from triggers to alert other users to changes in the data.

3.4 And then there was IBX

Firebird provides a client library (DLL under Windows, shared object (.so) under Linux) through which an Application Program Interface (API) is made available. This API is “low level” providing a basic set of functions with the data accessed through untyped pointers. This is a flexible approach, allowing use from many different programming environments, whilst requiring work from the client program to make sense of the data.

For 'C' programs, Firebird provides a pre-processor (gpre) that allows SQL statements to be embedded into the code and which then generates the 'C' code necessary to pass those statements to Firebird for execution and to pass input and receive output data to and from 'C' data structures. However, no such pre-processor is available for Pascal.

When Borland released Delphi in the mid-nineties, it was arguably a revolutionary development in visual programming. It also came with a model for database programming that included an abstract model of a dataset and “data aware” controls. That is a means to link the controls (or widgets) placed on forms with the fields in a dataset. This all works well as long as the abstract dataset can be somehow made “concrete” and linked to the datasets provided by the RDBMS that the developer wants to use.

The first versions of Delphi worked well with Paradox tables and included middleware known as the Borland Database Engine (BDE) to provide drivers for SQL databases, including InterBase (a trial version was shipped with Delphi). The BDE was probably not the most efficient solution for the problem.

One improvement on this was the Free IB Components, written by Gregory H. Deatz for the Hoagland, Longo, Moran, Dunst & Doukas Company. This was licensed by Borland and then provided with Delphi as InterBase Express (IBX).

IBX provided a direct implementation of the abstract dataset model for InterBase, using the API direct from a Delphi (Pascal) program. It allowed the programmer to define the datasets using SQL and to update data using SQL, whilst keeping within the Delphi dataset model. By making direct use of the InterBase API it potentially gives the best performance possible to a Delphi program.

When Borland/Inprise released InterBase under an Open Source licence in 2000, it also released the IBX codebase under the same licence. In 2011, a fork of the IBX Open Source release was

used by MWA Software to create *IBX for Lazarus*. This version of IBX was developed to work with the Lazarus LCL and to use the Firebird RDBMS in either embedded or standalone server mode.

Since its original release, *IBX for Lazarus* has been both maintained and extended with the introduction of additional components including an SQL Parser and script engine. In 2016, IBX2 included support for the new Firebird 3 API. This version includes a separate set of Pascal Language Bindings (the *fbintf* package) that provides the foundation for IBX2. The *fbintf* package can be used to effectively embed SQL statements within Pascal code.

4

IBX Overview

The purpose of IBX is to provide an implementation of the TDataSet model, and hence a data source for Data Aware components, and doing so by making direct use of the Firebird API. There is no middleware involved and the intent is to maximise performance. IBX is intended to provide the best performance possible when using Firebird from a Pascal program.

Firebird is an SQL database and a knowledge of SQL is generally necessary for all but basic use of IBX. IBX does not attempt to hide the SQL from the programmer¹. Indeed, it gives the programmer full use of SQL.

The *IBX for Lazarus* components should behave identically to their Delphi equivalents and many online tutorials are available on how to use them. An introduction to their use is given below, and many example programs are also provided.

4.1 Conversion From Delphi IBX

You should be aware of the following issues:

1. The IBX components make use of the TThread class, and, as such require that multi-threading is enabled. Specifically, in the Linux environment, the “-dUseCThreads” option must be present in the “Compiler Options->Options->Custom Options” and set for every Lazarus project that uses them.
2. Prior to FPC 2.6.0, the TIntegerField type may cause problems when porting code from Delphi to Lazarus.
3. FMTBcd is not yet implemented by the Free Pascal Compiler. IBX for Lazarus thus uses the TFloatField type for extended floating point (64 bit) fields. This may cause problems where converting Delphi programs to Lazarus. The recommended approach is to change all

¹The exception to this is the TIBTable and TIBStoredProc components. These can be used for simple database applications without requiring any SQL programming.

TFmtBcdField types to TIBBcdFields. This will allow Delphi forms to be converted to Lazarus. However, some of the conversions will not give the correct results. Typically, this will result in field values that appear to be of the order of several billion when the program is run. To resolve the problem, delete the field in the IDE Fields editor and then re-create it. The correct field type will then be used.

Alternatively, all TFmtBcdField fields should be deleted prior to conversion and then recreated in the IDE.

4.2 IBX in Context

The following diagram attempts to position IBX with respect to other packages. As illustrated the *fbintf* package is the provider of the Firebird API and may be both directly access by the user, while also providing the Firebird API to IBX. IBX is also accessed directly by the user, but also uses the FCL which is where the TDataSet abstract class is located. IBX can make use of the LCL but only does so when not in console mode and this is only to provide the built-in Login Dialog.

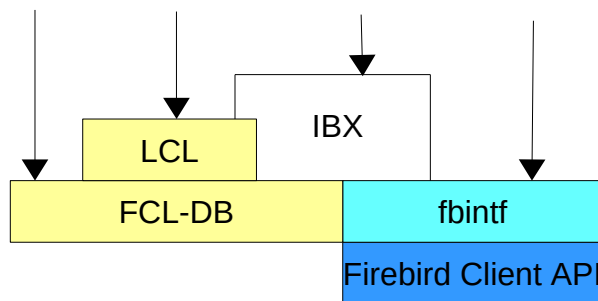

Illustration 1: How IBX Relates to other Packages

4.3 IBX Lazarus Packages

IBX is deployed as a set of Lazarus packages, organised as follows:

- **ibnongui** This is the base set of IBX components and comprises all common IBX components that do not require the LCL. Use this package in console mode applications.
- **ibexpress** This packages depends on ibnongui and adds the LCL dependent units. These provide the built in login dialogs and the “hour glass” cursor support for time consuming database operations. Use this package for LCL based applications.
- **ibLegacyServices** This package depends on ibnongui and adds the legacy services API components contained in the IBServices unit (see Appendix A.). This may be used in both CLC console mode applications.

- **iblocalnongui** This package depends on `ibnongui` and adds the Personal Database support components (see chapter 11) for console mode applications.
- **iblocal** This package depends on `ibexpress` and `iblocalnongui` and adds the Personal Database support components for LCL applications.
- **ibcontrols** This package depends on `ibexpress` and adds the IBX Controls components (See chapter Error: Reference source not found).
- **dclibx** This is the design time package used to install IBX into the Lazarus IDE.
- **ibexpressconsolemode** In previous versions, this package was used by console mode applications using IBX. It is still available for legacy use and depends upon both `ibnongui` and `iblocalnongui`.

In the most cases, it is not necessary to explicitly add an IBX package to your project as the Lazarus IDE does this for you when you “drop” an IBX component on to a form in your project. Only when developing console mode applications will you need to explicitly add one or more of the non GUI packages to your project dependencies.

4.4 Component Overview

The following components are installed on the Firebird tab:



TIBDatabase

Every project that uses IBX must have at least one `TIBDatabase` component. This is usually placed on a data module or the main form, and represents the connection to the database. Its properties identify the server on which the database is located, its name or pathname on that server, the login credentials, and the local character set when transliteration is required. It can also generate a login prompt for the user name and password, or support a user provided login form. See 5.1.



TIBDatabaseInfo

This component supports a `TIBDatabase` and provides read only access to a database's properties and statistics. See 7.5.



TIBTransaction

Every project that uses IBX must have at least one `TIBTransaction` component. Firebird is a transaction oriented database and all operations must take place in the context of a transaction. Its properties determine the transaction isolation (see Firebird documentation). A `TIBTransaction` is typically provided with the `TIBDatabase` and linked to it by the `TIBDatabase.DefaultTransaction` property. See 5.2.



TIBQuery

This component is a descendent of `TDataset` and generates the dataset from the results of an SQL query (Select statement or a

Stored Procedure that returns a results set). The SQL query used is given by its SQL property. This can be parameterised with the values of the parameters set before the query is executed. When the “active” property is set to true then the query is executed and the results set returned. When “active” is set to false, the results set is discarded. The dataset is read only unless its “UpdateObject” property references a TIBUpdateSQL or a TIBUpdate object.

The TIBQuery's properties must identify the database and the transaction used for executing the query. See 6.5.



TIBUpdateSQL

This component may be referenced from a TIBQuery component and is used to support updateable queries. It provides SQL statements to:

- Delete the current row in the results set
- Refresh (from the database) the current row in the results set
- Update the current row in the database to match the (modified) values in the database
- Insert a new row into the database.

See 6.6.



TIBUpdate

This component may be referenced from a TIBQuery component and is a more general way to support updateable queries than that provided by TIBUpdateSQL. While TIBUpdateSQL supports single SQL statement for Delete, Update or Insert, TIBUpdate provides an event handler for Update, Insert or Delete together with an ISQLParams interface providing access to all current and “old” field values. This gives the programmer complete freedom as to how the Update, Insert or Delete is performed.



TIBDataSet

This is also a TDataSet descendent and combines the functionality of TIBQuery and TIBUpdateSQL into a single component. See 6.7.

Its properties must identify the database and the transaction used for executing the query.

You will normally want to use TIBDataSet instead of a TIBQuery and TIBUpdateSQL pair. Alternatively, the latter combination may be used, for example, when a form uses a TIBQuery to provide a read only dataset, and a subclassed (inherited) form needs to update the dataset. The TIBUpdateSQL can be added to the subclassed form to provide the update capability.



TIBStoredProc

This component is used to execute a stored procedure (on the Database Server), and one that does not generate a results set. Its properties must identify the database and the transaction used for executing the query. See 6.4.



TIBSQL

This component is the basic SQL engine of IBX and is used internally by TIBQuery, TIBDataset and TIBStoredProc to perform SQL queries. It can be used directly by the programmer to effectively implement embedded SQL statements.

Its properties must identify the database and the transaction used for executing the query.

TIBSQL is essentially an object oriented encapsulation of the Firebird DSQL API. See 6.5.



TIBEvents

One very useful feature of the Firebird Database is its ability to generate asynchronous “events” from a Stored Procedure or Trigger and which can then be acted upon by any active client that is listening on the event. Database clients can thus act immediately on changes made by another client without needing to regularly query the database.

The TIBEvents component is used to register for and receive Firebird Events. Up to 16 events can be waited upon simultaneously. The name of each event to be listened to is set in the component's Events property. If you need to wait on more than 16 events, then additional TIBEvents components can be used.

The event notification is asynchronous and takes place at the end of the transaction in which the event was generated. A separate thread is used by TIBEvents to wait on the event notification. When the event occurs it calls the “OnEventAlert” event handler to report which event has been received. Note that the event handler is run in the context of the main thread and hence there is no need to worry about thread synchronisation. See 5.3.



TIBSQLMonitor

This component supports debugging and performance tuning by allowing one process to monitor the SQL function calls in the same or another process (on the same system).

The TIBDatabase trace flags determine which function calls can be traced with respect to its database connection. However, a process only starts to broadcast its function calls after an explicit call to the `TIBSQLMonitor.EnableMonitoring` procedure, and stops after a call to `TIBSQLMonitor.DisableMonitoring`.

To receive SQL Function call traces, you need to place a TIBSQLMonitor component on your form. The properties of this component can be set to filter the SQL function calls to what you are interested in. The OnSQL event handler is used to receive and process SQL function call trace events. See 7.4.

Note that the Windows implementation allows any process to monitor the SQL Trace events broadcast by another. The Linux implementation restricts monitoring to processes owned by the same user.



TIBTable

This component provides a simple TDataSet descendent where the contents of the dataset are the same as a named Database Table. This component is useful for very simple applications, but TIBDataset should normally be preferred for most applications. It also supports Master/Detail relationships between linked tables. See 6.3.



TIBExtract

This component allows the extract of database metadata. The component is intended to be compliant with all Firebird extensions to the DDL up to and including Firebird 3. See 7.6.



TIBBatchMove

This component supports a table to table copy from a source IBX dataset to a TIBTable.



TIBXScript

This component is used to run an SQL script in the specified file or stream. The text is parsed into SQL statements which are executed in turn. The intention is to be ISQL compatible but with extensions. See 7.1.

The Firebird Admin tab provides the Service API components. These support various server side functions including user password maintenance and database backup/restore (see 10.2).

4.5 Databases and Transactions

IBX always access a database through a “connection” whether it is a local database or a remote one. Data is the read and written in the context of a transaction. Transactions exist:

- to isolate users from each other,
- to allow a user to see a consistent view of the data independent of what other users are doing,
- to allow users to lock data for change and to control whether other users wait on such locked data, and
- to provide a well defined transaction start and end where, at a transaction end, any changes made to the data are either committed and made available for other users to see, or are abandoned and the data rolled back to where it was before the transaction started.

Firebird is a transaction oriented database and all interactions with the database have to take place in the context of a transaction. Firebird allows multiple independent transactions to take place simultaneously and provides several possible isolation strategies in order to avoid the transactions interfering with each other.

At least one TIBDatabase (see 5.1) and one TIBTransaction (see 5.2) component are required for an application that uses IBX. These are normally placed on the project's main form or on a data module. The TIBDatabase component represents the connection to a database, and it's rare than a project needs more than one such component (e.g. if you need to support simultaneous connections to two or more databases).

The TIBDatabase component's properties identify the location of the database and provide the logon parameters. It can also use a built in dialog to prompt for a user name/password or use an application provided dialog. A default transaction is also identified in the TIBDatabase properties. Datasets linked to this database automatically use the default transaction unless this is explicitly overridden in the dataset's properties.

TIBTransaction represents a transaction, and, you can have as many TIBTransaction components as necessary. A TIBTransaction is normally linked to single database (TIBDatabase) but can be linked to multiple databases in order to synchronise updates to them.

4.6 Datasets

The TDataset model is integral to the managing the relationship between Data Aware controls and database tables in both Lazarus and Delphi. A TDataset derived component is used, at its simplest, to represent the data in a single database table. Data aware controls, such as TDBEdit can then be linked to a single (text) column in the dataset and allow the data in the current row of that column to be both displayed and edited. A control such as TDBGrid allows multiple rows to be shown together and as a table.

An example of this is shown in Illustration 2. This is a snapshot from the example application (see the “ibx/examples/employee” directory) and illustrates the use of TDBGrid to show a table of database data.

4.6.1 Datasets and Transactions

Each dataset is linked to a single transaction and all data reads and writes using that dataset take place in the context of this transaction.

In a simple application, you only need to include a single TIBTransaction component with your application.

- In the most basic case, the first dataset to be activated implicitly starts the transaction (as long as its AutoActivateTransaction property is set) and, if, when it is deactivated, no other datasets are active, it will automatically commit the transaction. When the database is closed, the default action of the TIBTransaction is to commit all changes.
- In a more advanced application (such as the example application), you will want more control over committing or rolling back the transaction and TIBTransaction provides methods to start a transaction and to commit it or roll it back. In this case, it is usually advisable to explicitly start each transaction rather than relying on implicit starts as this avoids a dataset unexpectedly committing a transaction when it is closed. Commit and Rollback are then always under programmatic control.

Note that when a transaction ends, all datasets referencing the transaction are automatically deactivated. A new transaction has to be started and those datasets reactivated if they are to continue to be populated.

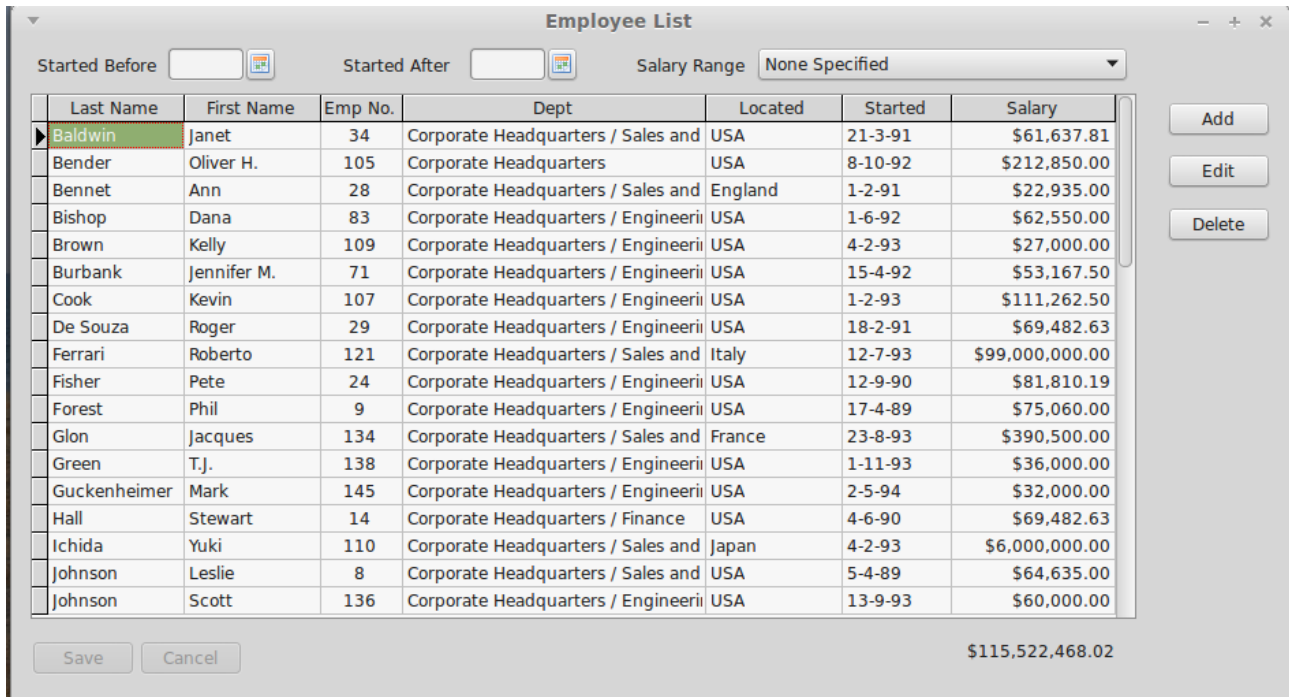

Illustration 2: Employee List from the examples/employee application

However, it is possible to save changes (commit the transaction) and to not close the datasets. This is by using the `TIBTransaction.CommitRetaining` method. This commits the transaction whilst retaining the transaction context. The datasets can thus remain open. The downside of using this function is that in a multi-user database, the datasets only pick up changes made by other users when they are closed and re-opened.

4.6.2 Single Table Datasets

While a single table may be used for simple applications, the dataset is more normally the result of a database query where the result is one or more rows. In some cases, the dataset may just consist of a single row where it is supporting a form that edit's that row's contents. This avoids the overhead of reading many rows from a database when only a single one is needed.

In IBX, the `TIBTable` component is a `TDataset` descendent that allows a single table to be named and, on your behalf, it does all that is necessary to read the rows in the table and update them as required. It does this by automatically generating the SQL Statements needed to access and update the database. However, this is a limited approach, and does not allow the full power of SQL to be exploited.

4.6.3 SQL Defined Datasets

IBX also provides `TIBQuery`. This is also a `TDataset` descendent but reads a dataset that is the result of an SQL Select Query specified by the programmer either a design to runtime. The query can join multiple tables and be limited to just the rows required. It is much more powerful than just accessing a single table.

If you need also to update the database after editing a `TIBQuery` results set, another component (`TIBUpdateSQL`) can be linked to the `TIBQuery` to provide the SQL Statement necessary to Update, Insert or Delete rows, or to refresh rows that may have changed.

More generally, TIBDataset is a component that allows you to specify the Select, Update, Insert, Delete and Refresh queries in one component.

4.7 Examples

The `ibx/example/employee` example application provides an example of the use of the TIBDatabase, TIBTransaction, TIBQuery and TIBDataset components supporting data aware components for viewing and editing data from a database.

5

The Database Access Components

The IBX components are presented here in three main groups. This chapter is concerned with the “Database Access” set of components. Chapter 6 is concerned with the dataset components, while chapter 7 presents support components.

The IBX Database Access components are simply those components that are little more than “wrappers for interfaces exported by the *fbintf* package, and are:

- TIBDatabase – encapsulates the IAttachment interface
- TIBTransaction – encapsulates the ITransaction interface
- TIBEvent – encapsulates the IEvents interface
- TIBSQL – encapsulates the IStatement interface.

The Firebird Pascal API describes each of these interfaces in detail and how to use them. However, when using, you should use the methods and properties provided by the component in preference to similar methods and properties provided by the underlying interface, except as described below.

5.1 TIBDatabase

This is a non-visual component and a TCustomConnection descendent. It provides the link between the database connection as viewed by the TDataset model and the Firebird database connection.

5.1.1 Highlighted Properties

Connected	Set this property to true to connect to a database and to false to disconnect.
AllowStreamConnected	This property exists to avoid a conflict between connecting to a database at design time and automatically connecting at run

	time. (see 5.1.11).
ConfigOverrides	This is a list of configuration settings in the same syntax as the "firebird.conf" file. It may be used to provide client side settings that override the defaults in the local "firebird.conf" file.
CreateIfNotExists	New in IBX2: If true, and an attempt is made to connect to a database that does not exist, then the database is created, if possible. See also the OnCreateDatabase event.
DatabaseName	<p>The database connection string including the server name (localhost or empty for a local server) and the database path or alias. The format varies depending on the connection protocol used and the way pathnames are expressed on the target system. See the Firebird documentation for more information. e.g.</p> <p><code>inet://myserver/employee</code></p> <p>is the connect string for the example employee database on "myserver" using TCP as the connection protocol.</p> <p>Note: from IBX 2.2 onwards, local database names can include simple macros. See 5.1.2.</p>
DefaultTransaction	Reference to the default transaction for the database. This is purely a convention. When a dataset is linked to a TIBDatabase, it's default transaction is assigned as the dataset's transaction if none is already specified.
FirebirdLibraryPathName	<p>This published property is normally left empty. If not empty then it should be set to the pathname for the Firebird Library (DLL or so). If empty, IBX searches well known locations for the library. The property is typically used when the library file is not in an expected location or to force the selection of a specific file when several versions are available. (see also 5.1.12).</p> <p>Note: the pathname syntax is platform dependent.</p>
FirebirdAPI	This read only public property returns the IFirebirdAPI interface to the Firebird Library used to access the database.
IdleTimer	If non-zero, this is the time in milliseconds between successive polls for database activity. If no activity has been detected between two successive polls then the database is automatically disconnected. Can be used to timeout idle connections if needed.
LoginPrompt	When true, the a login dialog is shown to the user to confirm the database user name (as given in the Params) and to enter a password. If the OnLogin event handler is defined then this is

	called and is expected to generate the login dialog. Otherwise, the built-in login dialog is used.
Params	This is a list of parameter values to be used in the Database Parameter Block (DPB) at connect time. These are in "keyword=" format. See below.
SQLDialect	The default SQL dialect to be used for when creating a database (3 is recommended). See Firebird Documentation.
SQLHourGlass	If true, then the cursor is changed to an Hour Glass (or equivalent) during calls to the database server.
UseSystemDefaultCodePage	If true, then the system default code page is used as the connection default character set. Not recommended for Lazarus programs where UTF8 is assumed by many LCL functions.
WireCompression	<p>This is a "convenience" property. If set to true then "WireCompression=true" is added to the ConfigOverrides property, If set to false then then "WireCompression=" line is removed from ConfigOverrides.</p> <p>Note: you may set "WireCompression=false" explicitly in the ConfigOverrides in order to override a default of "WireCompression=true".</p>

5.1.2 DatabaseName Macros

In order to aid the development of cross platform applications that use local databases in well known locations, from IBX 2.2 onwards, the DatabaseName property value can include simple macros used as prefixes for database names.

The following prefixes are available:

- \$TEMP\$

Before connecting to a database, this is replaced with the local system's temp directory (including trailing delimiter).

- \$DATADIR\$

Before connecting to a database, this is replaced with a prescribed data directory (including trailing delimiter).

Under Unix systems the data directory is a hidden directory in the user's home directory. The hidden directory name is either the string returned from the SysUtils "VendorName" or "IBX" if empty. In either case prefixed by a '.'.

Under Windows, the directory is either the string returned from the SysUtils "VendorName" or "IBX" if empty. In either case prefixed by the User's application data path.

For example: "\$TEMP\$1DTest.fdb" is expanded on Linux to "/tmp/1DTest.fdb".

Note: These macros are used in the IBX examples to avoid platform dependencies.

5.1.3 Parameter Keywords

The parameters are best edited at design time using the database dialog editor (double click on the TIBDatabase component icon, once it has been placed on your form). The parameter names available include:

user_name	Login user name
password	Login password (use of this parameter to save a password at design time is not recommended).
lc_ctype	Name of the connection default character set (e.g. UTF8). UTF8 is recommended for Lazarus programs.

5.1.4 Highlighted Events

TIBDatabase events are typically used to react to changes in the connection state. These include:

AfterConnect	Called after a connection has been successfully established. A good place to start the first transaction and open datasets.
AfterDisconnect	Called after a connection has been disconnected.
BeforeConnect	Called before an attempt is made to connect to a database. Could be used to update the connection parameters, database name, etc.
BeforeDisconnect	Called before an attempt is made to disconnect from a database.
OnCreateDatabase	Called after a database has been successfully created. Could be used to run a DDL script (e.g. using TIBXScript – see 7.1) to initialise the database.
OnIdleTimer	Called after an idle timer has disconnected the database.
OnLogin	Called if LoginPrompt is true and maybe used to complete the login parameters by prompting the user. If not set and LoginPrompt is true then the built in login dialog is used.

5.1.5 Connecting to a Database

The recommended approach is:

- To set AllowStreamedConnect to false
- Do not include a password in the parameters
- Use the built-in or a user defined login prompt to confirm the user name and enter the password.

The following code is recommended for setting the connected property to true. This may be part of an OnShow handler for the main form or when otherwise required:

```
repeat
  try
    IBDatabase1.Connected := true;
  except
    on E:EIBClientError do
      begin
        Close;
        Exit
      end;
    On E:Exception do
      MessageDlg(E.Message,mtError,[mbOK],0);
    end;
  until IBDatabase1.Connected;
```

An example of this code in use may be found in “ibx/example/employee”. The purpose of the above is to trap and report errors, such as mis-typed passwords whilst allowing the user to click on cancel and exit through a “client error”.

Note: you will need to add the “IB” unit to your units list in order for the above to compile.

When the connection is opened, the DatabaseName property provides the “connect string” and determines the server name and database name on the server. A Database Parameter Block (DPB) is used to provide the required settings for the connection. This is generated from the “Params” and “ConfigOverrides” properties. The former provides information such as the user name, password and role name. The latter provides a list of configuration settings in the same syntax as the “firebird.conf” file. It may be used to provide client side settings that override the defaults in the local “firebird.conf” file.

5.1.6 Database Disconnect

You can disconnect from a database at any time by setting the Connected property to false. However, it is not necessary to explicitly disconnect before a program terminates as this is performed automatically when the TIBDatabase component is destroyed.

5.1.7 Reconnecting

The Reconnect method may be used to disconnect and then reconnect to a database. This can also be achieved by setting the Connected property to false and then true e.g.:

```
IBDatabase1.Connected := false;
IBDatabase1.Connected := true;
```

However, the above may cause the user to be prompted to re-enter their user name and password. The Reconnect method uses the current user name and password and hence avoids having to re-prompt the user.

5.1.8 Creating a new Database

The CreateDatabase method can be used to explicitly create a new database, alternatively, if the CreateIfNotExists property is set to true then a new database is automatically created if the connection attempt fails with a database not found error.

The DatabaseName property is used to determine the location of the database and the Params property provides the create parameters, including the database owner (user_name), and the database default character set (lc_ctype). The SQLDialect property determines the database SQL Dialect.

Alternatively, the CreateDatabase method may be called with a "CREATE DATABASE" sql statement. In this case, the sql statement is the sole source of the create parameters.

Once the database has been created, the OnCreateDatabase event is called. An SQL script may now be run to initialise the database, (e.g.) by using TIBXScript (see 7.1).

5.1.9 Dropping a Database

Once a connection has been established, it is possible to drop (disconnect and delete) a database using the DropDatabase method. This will delete the original database file, provided that the logged in user has sufficient privilege to do this operation.

5.1.10 Using the Attachment Interface

The TIBDatabase component also exposes the underlying IAttachment interface as the public property: Attachment. This can be used for embedded SQL. For example,

```
var employees: integer;
begin
  employees := IBDatabase1.Attachment.OpenCursorAtStart(
    'Select count(*) From Employees').AsInteger;
```

gets the current number of rows in the employee table. Use of the IAttachment interface is described in the Firebird Pascal API Guide.

From IBX 2.3.3 onwards, the Attachment property is read/write. This allows a single attachment (database connection) to be shared between multiple instances of TIBDatabase. For example:

```
IBDatabase2.Attachment := IBDatabase1.Attachment; {assumed already connected}
```

The above statement copies the attachment interface to IBDatabase2. This also causes the IBDatabase2 before and after connect event handlers to be called, if present.

If IBDatabase2 already had an attachment (to a different database with a compatible schema), the IBDatabase2 before and after disconnect handlers are also called. The old IBDatabase2 Attachment is released if no other reference exists to the same attachment.

5.1.11 Using the AllowStreamConnected Property

In order to get the lists of tables and fields and to test the SQL statements, property editors (see 6.5.3) need a connection to a development version of your database. They use the dataset's TIBDatabase to do this and may set its connected property to true in order to achieve this. However, when the form is saved, this can also result in the connected property being saved in the form as "true".

The result is that when the compiled program is run, the TIBDatabase component is loaded with a connected property set to true and is then in its "streamed connected" state. This is it connects to the database as soon as the component finishes loading. This may be what you want – which is fine. But often this is not desirable.

When a TIBDatabase connects to the database as soon as the component finishes loading, it causes problems with error handling. That is exceptions cannot be caught and a simple error, such as mistyping a password can cause an ungraceful exit; as far as the user is concerned the program has crashed.

To avoid this, it is better to set the connected property explicitly, perhaps once the main form has finished loading and in its OnShow event handler (see 5.1.5). It is then possible to wrap the "connected := true" with an exception handler.

This can be ensured by setting the TIBDatabase AllowStreamedConnected property to false. This prevents the component entering the "streamed connected" state even if the connected property is set to true when the form was saved.

5.1.12 Using a Firebird DLL or Shared Object Library in a non-default Location

IBX normally searches all well known locations for the Firebird DLL or Shared Object Library, and then loads it for use. This occurs automatically and there is no need for the user to configure the process. The search algorithm is discussed in section 3.3 of the "Firebird Pascal API Guide".

However, it is also possible to specify the relative or absolute pathname of the Firebird Library on a per database basis by setting the FirebirdLibraryPathName property to such a pathname. When this property is non-empty then, before the database is opened, IBX will attempt to load the specified DLL or shared object library and use the Firebird API exported by the library for the database connection and all derived objects (e.g. transactions, SQL queries, etc.).

If permitted by the OS, each database connection could use a different Firebird library. However, if a transaction uses multiple databases then each database connection must use the same Firebird library.

Note: the FirebirdLibraryPathName property is ignored at design time. When active in the IDE, IBX always looks for the Firebird Library in the well known locations. However, you can still use the FBLIB environment variable to provide the path to the Firebird library in a non-standard location when using IBX in the IDE (see section 3.3.4.1 of the Firebird Pascal API Guide. Note that the **AllowUseOfFBLIB** global variable is, by default, set to true at design time.

The FirebirdLibraryPathName property may be set at design or run time. However, the syntax is platform dependent and the actual location of the required Firebird may differ between individual systems. Most users will thus prefer to set the property at run time, with the pathname read from a program argument or a configuration file, or even entered by the user.

If the `FirebirdLibraryPathName` property is changed while the database connection is open, the connection is closed and must be explicitly re-opened.

5.2 TIBTransaction

This non-visual component is a wrapper for the `ITransaction` interface. Its role is to:

- Provide a component that represents a transaction
- Provide a means to specify transaction parameters at design time.
- Allow design time references to be established between datasets, transactions and databases.
- Provide a centralised point for event handling when transactions are started or closed, or to react to state changes in datasets linked to transactions (e.g. to indicate data changes).

The simplest way to set transaction parameters at design time is to use the transaction editor. This is accessed by double clicking on the `TIBTransaction` component icon, once it has been placed on your form.

5.2.1 Highlighted Properties

Active	Set to true to start a transaction. Returns true when a transaction is active. Set to false to close a transaction and rollback. When set at design time will cause the transaction to be started as soon as it has loaded.
DefaultAction	Set to <code>taCommit</code> or <code>taRollback</code> . Determines the default closure of the transaction if implicitly closed.
DefaultDatabase	A reference to the default <code>TIBDatabase</code> for the transaction.
IdleTimer	If non-zero, this is the time in milliseconds between successive polls for transaction activity. If no activity has been detected between two successive polls then the transaction is automatically closed. Can be used to timeout idle transactions if needed.
IsReadOnly	Returns true for a read only transaction
Params	This is a list of parameter values to be used in the Transaction Parameter Block (TPB) at connect time. These are in "keyword=" format. See below
TransactionID	This is the unique transaction id returned by Firebird.
TransactionName	The name of the transaction. This is typically assigned at design time and may be used to locate a transaction object. e.g. during transaction playback. Defaults to a unique GUID.

5.2.2 Events

AfterDelete	Called after a record has been deleted in a dataset linked to the transaction.
AfterEdit	Called after a dataset linked to the transaction has entered the edit state.
AfterExecQuery	Called after a TIBSQL component linked to the transaction has executed a query.
AfterInsert	Called after a dataset linked to the transaction has entered the insert state.
AfterPost	Called after a dataset linked to the transaction has posted changes.
AfterTransactionEnd	Called after the transaction has been closed.
BeforeTransactionEnd	Called before the transaction is closed.
OnIdleTimer	Called after the transaction has been closed due to lack of activity.
OnStartTransaction	Called after a transaction has been started.

5.2.3 Transactions and Databases

In most cases, a transaction is linked to only a single database (the `DefaultDatabase`) and the transaction takes place in the context of the associated database connection. However, a transaction can be linked to more than one database.

Additional databases must be added at run time using the `AddDatabase` method and before the transaction is started. They can also be removed using the `RemoveDatabase` method. The public property `Databases` can be used to inspect the current set of databases linked to the transaction.

When more than one database has been added to a transaction, the transaction becomes a multi-database transaction co-ordinating updates over the set of databases.

5.2.4 Starting a Transaction

A transaction can either be started implicitly when (e.g.) a dataset is opened or explicitly by setting the `Active` property to true, or by calling the `StartTransaction` method.

Note: From IBX2 onwards, at run time, implicit start has to be enabled using the dataset's `AllowAutoActivateTransaction` property.

Implicit start occurs when a dataset is opened (active property set to true) and the linked transaction has not been started. In this case, the transaction is automatically started when the dataset is opened. It can also occur when the transaction's `Active` property is set at design time

and immediately after the form on which the transaction component has been placed, completes loading.

An explicit transaction start can be performed at any time while the linked database is connected. However, an exception is raised if the transaction is already started. The recommended code is:

```
IBTransaction1.Active := true;
```

Explicit start of transactions is recommended for all but the most simple applications as this allows better control over error handling and is part of a properly thought out use of transactions.

5.2.5 Transaction Parameters

The following keywords may be given as transaction parameters. Except as where indicated, the parameters have no value associated with them and hence are not followed by an “=” sign. Transaction parameters can also be set using the Transaction Editor (see 5.2.6).

consistency	Table-locking transaction model
concurrency	High throughput, high concurrency transaction with acceptable consistency; use of this parameter takes full advantage of the Firebird multi-generational transaction model [Default]
shared	Concurrent, shared access of a specified table among all transactions; use in conjunction with <code>_lock_read</code> and <code>lock_write</code> to establish the lock option [Default]
protected	Concurrent, restricted access of a specified table; use in conjunction with <code>lock_read</code> and <code>lock_write</code> to establish the lock option
exclusive	Same as “protected”
wait	Lock resolution specifies that the transaction is to wait until locked resources are released before retrying an operation [Default]
nowait	Lock resolution specifies that the transaction is not to wait for locks to be released, but instead, a lock conflict error should be returned immediately
read	Read-only access mode that allows a transaction only to select data from tables
write	Read-write access mode of that allows a transaction to select, insert, update, and delete table data [Default]
lock_read	Read-only access of a specified table. Use in conjunction with <code>shared</code> , <code>protected</code> , and <code>exclusive</code> to establish the lock option. Table name given as parameter value.

lock_write	<p>Read-write access of a specified table. Use in conjunction with shared, protected, and exclusive to establish the lock option [Default].</p> <p>Table name given as parameter value.</p>
verb_time	<i>This is poorly documented and its use uncertain. Do not use unless you know how it works.</i>
commit_time	<i>This is poorly documented and its use uncertain. Do not use unless you know how it works.</i>
ignore_limbo	Do not wait for Limbo Transactions. Used for a garbage collector thread.
read_committed	High throughput, high concurrency transaction that can read changes committed by other concurrent transactions. Use of this parameter takes full advantage of the Firebird multi-generational transaction model.
autocommit	Server performed auto-commit of each change.
rec_version	Enables a "read_committed" transaction to read the most recently committed version of a record even if other, uncommitted versions are pending.
no_rec_version	Enables a "read_committed" transaction to read only the latest committed version of a record. If an uncommitted version of a record is pending and "wait" is also specified, then the transaction waits for the pending record to be committed or rolled back before proceeding. Otherwise, a lock conflict error is reported at once.
restart_requests	<i>This is poorly documented and its use uncertain. Do not use unless you know how it works.</i>
no_auto_undo	With no auto undo, the transaction refrains from keeping the log that is normally used to undo changes in the event of a rollback. Should the transaction be rolled back after all, other transactions will pick up the garbage (eventually). This option can be useful for massive insertions that don't need to be rolled back. For transactions that don't perform any mutations, no auto undo makes no difference at all.
lock_timeout	This takes a non-negative integer as the parameter value, prescribing the maximum number of seconds that the transaction should wait when a lock conflict occurs. If the the waiting time has passed and the lock has still not been released, an error is generated.

The following is a suggested parameter list for a typical read/write transaction:

```
read_committed  
rec_version  
nowait
```

5.2.6 The Transaction Editor

The transaction editor is opened at design time by double-clicking on the TIBTransaction component once it has been placed on a form.

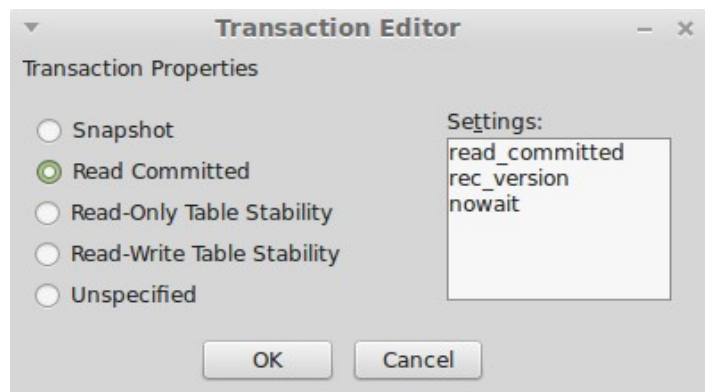

Illustration 3: Transaction Editor

This editor allows the transaction parameters to be set using one of the predefined options listed on the left. The result of selecting “Read Committed” is to set the Params property to that given in the Settings listbox.

5.2.7 Closing a Transaction

A transaction can either be closed implicitly with the default closure (commit or rollback) or explicitly.

Implicit closure occurs:

- When the database connection is closed.
- When the transaction idle timer expires.
- When a dataset that implicitly started a transaction closes and there are no other open datasets that are linked to the transaction.
- When the transaction's active property is set to false.

Explicit closure uses the Commit or Rollback methods and may be called at any time on an active transaction.

When a transaction is closed, all linked datasets that are still opened are closed implicitly and their data discarded.

Note: it is important to consider how your datasets react to transaction closure. See 6.6.5.

5.2.8 Retaining Transaction State after Closure

When explicitly closed, it is possible to retain the transaction state after a transaction has been closed by using the `CommitRetaining` or `RollbackRetaining` methods.

In either case, the effect is to immediately restart the transaction after the closure. As the database engine retains transaction state, there is no need for implicit closure of linked datasets. They thus remain open and there is no need to refresh their data.

The downside of using `CommitRetaining` or `RollbackRetaining` is that in a multi-user database, the datasets only pick up changes made by other users when they are closed and re-opened.

5.3 TIBEvent

This non-visual component is a wrapper for the `IEvents` interface. Its role is to:

- Provide a component that represents an event handler
- Provide a means to specify the events on which an application is waiting for at design time.

5.3.1 Highlighted Properties

Database	A reference to the <code>TIBDatabase</code> for which this component is the event handler
Events	A string list containing the names of the current set of events for which the application wants to be alerted.
Registered	When true, the event handler is active and waiting for events. When set at design time, the event handler becomes active as soon as the linked database is connected.

5.3.2 Events

<code>OnEventAlert</code>	This event handler is called whenever an event alert is received from the database for one of the monitor events.
---------------------------	---

5.3.3 Using Events

Events are raised by the database engine when a `POST_EVENT` statement is executed by a stored procedure or Trigger. The `POST_EVENT` statement also names the event. For example:

```
POST_EVENT 'MYEVENT';
```

Once the transaction, in which the trigger or stored procedure runs under, has been committed, the event is sent to all connected clients that have registered to receive the event. These clients may then react to the event. For example, by refreshing affected datasets. This is particularly useful in

multi-user databases as it provides a mechanism by which changes made by one user can then be seen by other users looking at the same data and as soon as the change is committed.

The names of the events an application is waiting for are typically defined at design time and the Registered property set to true. Then, whenever the event is signalled the OnEventAlert event handler is called. It is up to the application to then decide what to do.

Note: the event handler is called asynchronously and may run at any time. However, it will run in the context of the application main thread and thread synchronisation is not required.

The event handler is called once for each named event and reports the number of times the event has been signalled. This can be used to avoid reacting to duplicate events.

5.4 TIBSQL

This is a non-visual component and is a wrapper for the IStatement interface. It is used by the dataset components to execute SQL statements and to access the results of select queries. It can also be used directly by applications in which case, its role is to:

- Provide a component that represents an SQL Statement
- Provide a means to specify statement SQL at design time
- Allow design time references to be established between an SQL Statement, the transaction used to execute the statement and the database connection.

IBX2 supports embedded SQL through the TIBDatabase.Attachment interface (see 5.1.10). However, you may still prefer to specify a statement at design time and as a component by using TIBSQL.

5.4.1 Highlighted Published Properties

Database	A reference to the TIBDatabase to which the SQL Statement applies
GenerateParamNames	If true then positional parameters are replaced by parameter names in the format "IBXParam nnn " where nnn represents the zero based position number. Most users may safely ignore this parameter.
UniqueParamNames	Ignored in IBX2. Uniqueness of parameter names is determined automatically.
GoToFirstRecordOnExecute	When true and the SQL Statement is a select query, the cursor is positioned at the first record, if any, after the query is executed.
ParamCheck	Default true. The SQL Statement is parsed for named parameters. If no parameters or positional parameters are used then this may be set to false and the parsing overhead avoided.
SQL	The SQL Statement as a multi-line string list.
Scrollable	If true then a scrollable cursor is opened when ExecQuery is

	executed for a SELECT statement. Note: scrollable cursors are supported by Firebird for local database connections only.
Transaction	A Reference to the transaction used to execute the SQL Statement. Must be active before the query is executed otherwise an exception is raised.

5.4.2 Using TIBSQL

TIBSQL can be used to specify an SQL Statement at design time and to link it to the transaction used to execute it and the database connection to which it applies. However, the SQL Statement still has to be executed and used programmatically. TIBSQL cannot be used as a data source for data aware controls.

5.4.2.1 Executing a Stored Procedure

For example, if a TIBSQL component (e.g. named IBSQL1) contains the SQL Statement:

```
Execute Procedure MyProc :Param1;
```

Then this could be executed using:

```
with IBSQL1 do
begin
  Transaction.Active := true; {make sure transaction active}
  ParamByName('MyProc').AsInteger := 1; {assume integer parameter}
  ExecQuery;
end;
```

In the above, the query is first prepared and then the parameter accessed by name and set to the value of one. The query is then executed.

Note that parameters can always be accessed by position using the Params public property, even when they also have a name. If more than one parameter has the same name, then setting a parameter by name applies the same value to all parameters with the same name. The syntax for parameter names is the same as used for the Firebird Pascal API IStatement interface (see the Firebird Pascal API Guide).

Parameter names are parsed and applied by the *fbinf* package (see the Firebird Pascal API section 6.1.1 for further details).

5.4.2.2 A Stored Procedure that returns Output

For example, if the store procedure is defined as:

```
Create Procedure MyProc(aParameter Integer)
  Returns (SomeText VarChar(64))
As ...
```

Then executing the query should return results. In the above, these are simply accessed by name using the FieldByName method. Alternatively, they can be accessed by position using the Fields property. For example:

```
with IBSQL1 do
```

```
begin
  Transaction.Active := true;
  ParamByName('MyProc').AsInteger := 1; {assume integer parameter}
  ExecQuery;
  writeln('Some Text = ',FieldByName('SomeText').AsString);
end;
```

Field Names are generally the same as the column or alias names given in the SQL Statement. However, there are exceptions. See the Firebird Pascal API Guide section 6.1.2 for further information.

Note: Firebird handles INSERT ... RETURNING and UPDATE ... RETURNING in the same way as stored procedures. Returned values are similarly accessed in the same way as stored procedure output parameters i.e. using the FieldByName method.

5.4.2.3 Executing a Select Statement

If the TIBSQL statement is a Select SQL Statement then it may return many rows of output. It may optionally also have input parameters similar to any other SQL Statement.

When the statement is executed, a uni-directional cursor is returned to the results set. The fields in each row of the results set may be accessed using the FieldByName method. Alternatively, they can be accessed by position using the Fields property. You can scroll forwards to the next row by calling the Next method. Once all rows have been returned, the EOF property is set to true. The query should be explicitly closed in order to free the results set.

Note: when a cursor is first opened, the cursor is placed on the first row unless the GoToFirstRecordOnExecute property is set to false. In which case, the Next method must be called prior to accessing the first row.

For example, if the database is the example “employee” database and the SQL Statement is:

```
Select EMP_NO, FULL_NAME From EMPLOYEES Order by 2;
```

then the following will execute the query and write out the results, one line at a time.

```
with IBSQL1 do
begin
  Transaction.Active := true;
  ExecQuery;
  while not EOF do
  begin
    write('EMP_NO = ',Fields[0].AsString);
    writeln(': Full Name = ',Fields[1].AsString);
    Next;
  end;
  Close;
end;
```

5.4.2.4 Batched Queries

Firebird 4 introduces the Batch Execution interface. This applies to Update and Insert queries only (i.e. not update/insert returning) and can be used to batch up many separate queries to be executed as a single operation. This can be used to minimise the client/server interfaces and to optimise server update/insert times.

TIBSQL simply provides a wrapper for the IStatement implementation of the Batch Execution interface. TIBSQL provides the following functions that support Batch Execution and call the IStatement equivalents:

```

procedure AddToBatch;
function ExecuteBatch: IBatchCompletion;
procedure CancelBatch;
function GetBatchCompletion: IBatchCompletion;
function GetBatchRowLimit: integer;
procedure SetBatchRowLimit(aLimit: integer);
function HasBatchMode: boolean;
function IsInBatchMode: boolean;

```

For more information see the Firebird Pascal API Guide, section 6.8.

5.4.3 The TIBSQL SQL Property Editor

The TIBSQL component has its own property editor for editing the SQL query property.

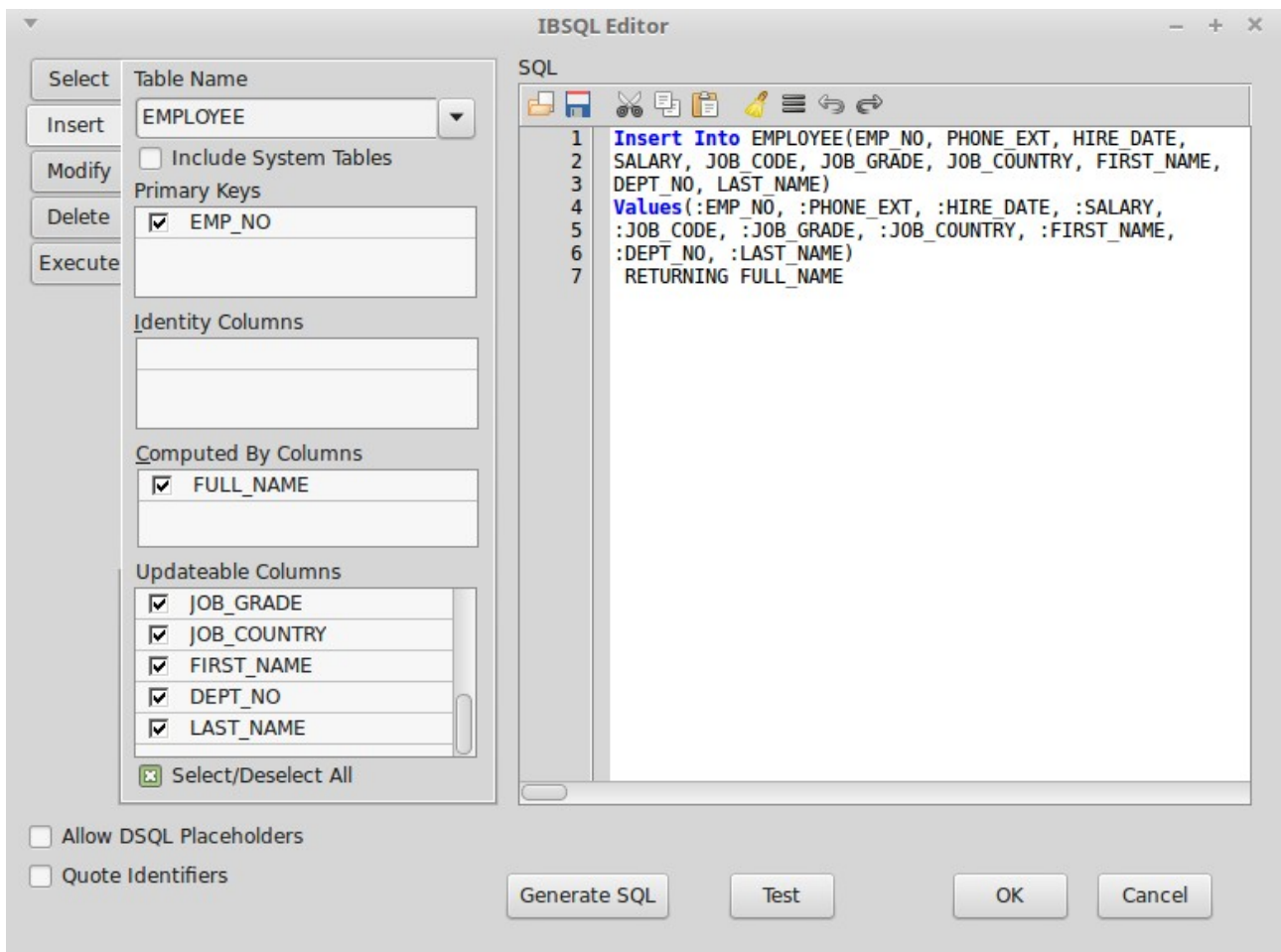

Illustration 4: TIBSQL SQL Property Editor

The property editor uses a SynEdit control to both display (using SQL syntax highlighting) and edit the SQL Statement. Any DDL or DML SQL statement may be given. The above example illustrates the use of an Insert statement.

Provided that the TIBSQL component is linked (at design time) to a valid database then:

- The SQL syntax can be tested using the “Test” button. When the “Test” button is clicked, the statement is passed to the Firebird Server for validation.

- The SQL Property Editor can also generate an initial SQL Statement which can then be edited by the user. The left hand tabs and panel are used to select the type and composition of the generated SQL statement.

In the above example, the Insert tab is selected implying that an Insert Statement is to be generated. The panel will then show an appropriate set of options, starting with the table name. The drop down list shows all tables in the database and the required table selected. The drop down list also uses auto-complete to simplify the selection with large numbers of tables in the database.

The available columns are then analysed into:

- Primary Keys (for the table)
- Identity Columns (Firebird 3 only – see 6.6.8)
- Computed By columns (i.e. columns computed by the server from other columns in the same row).
- Updateable Columns (i.e. all other columns).

By default all columns are selected. However, the mouse may be used to deselect the columns not required for the Insert Statement by clicking on the tick box.

When the “Generate SQL” button is clicked an Insert SQL Statement is generated:

- The selected primary keys are listed first except for those also selected as Identity Columns
- The selected Updateable columns then comprise the remainder of the insert statement.
- The selected Identity and Computed By columns are then listed in the RETURNING clause and, after the statement has been executed, their updated values can hence be retrieved from the TIBSQL.Fields property, or by using the FieldByName function (as discussed above for select queries).

Generation of Select, Update and Delete SQL statements follow similar rules, except that Identity columns are only relevant to Insert SQL Statements.

The generation of execute statements depends on the type of stored procedure (see Illustration 8).

From Firebird 3 onwards, SQL Property Editors now include a "Package Name" drop down box to allow selection of a Firebird 3 Package from which a stored procedure can be selected. With no package name selected, non-package stored procedures are listed, otherwise, the list is restricted to stored procedures in the selected package. In the illustration, the example package 'FB\$OUT' is selected and then the PUT_LINE stored procedure from this package.

Clicking on the “Generate SQL” key will generate an Execute Procedure SQL statement with the input parameters specified for the procedure. Note that while these are shown in the panel, the input parameters are not selectable (a requirement of the SQL syntax).

Similarly with output parameters. These are not normally selectable and are not included in the generated SQL. However, they can be read after the statement has been executed; their values can be retrieved from the TIBSQL.Fields property, or by using the FieldByName function (as discussed above for select queries).

The exception is for stored procedures that return multiple rows. In this case, a select statement is generated and the output parameters are selectable (see 5.4.2.3).

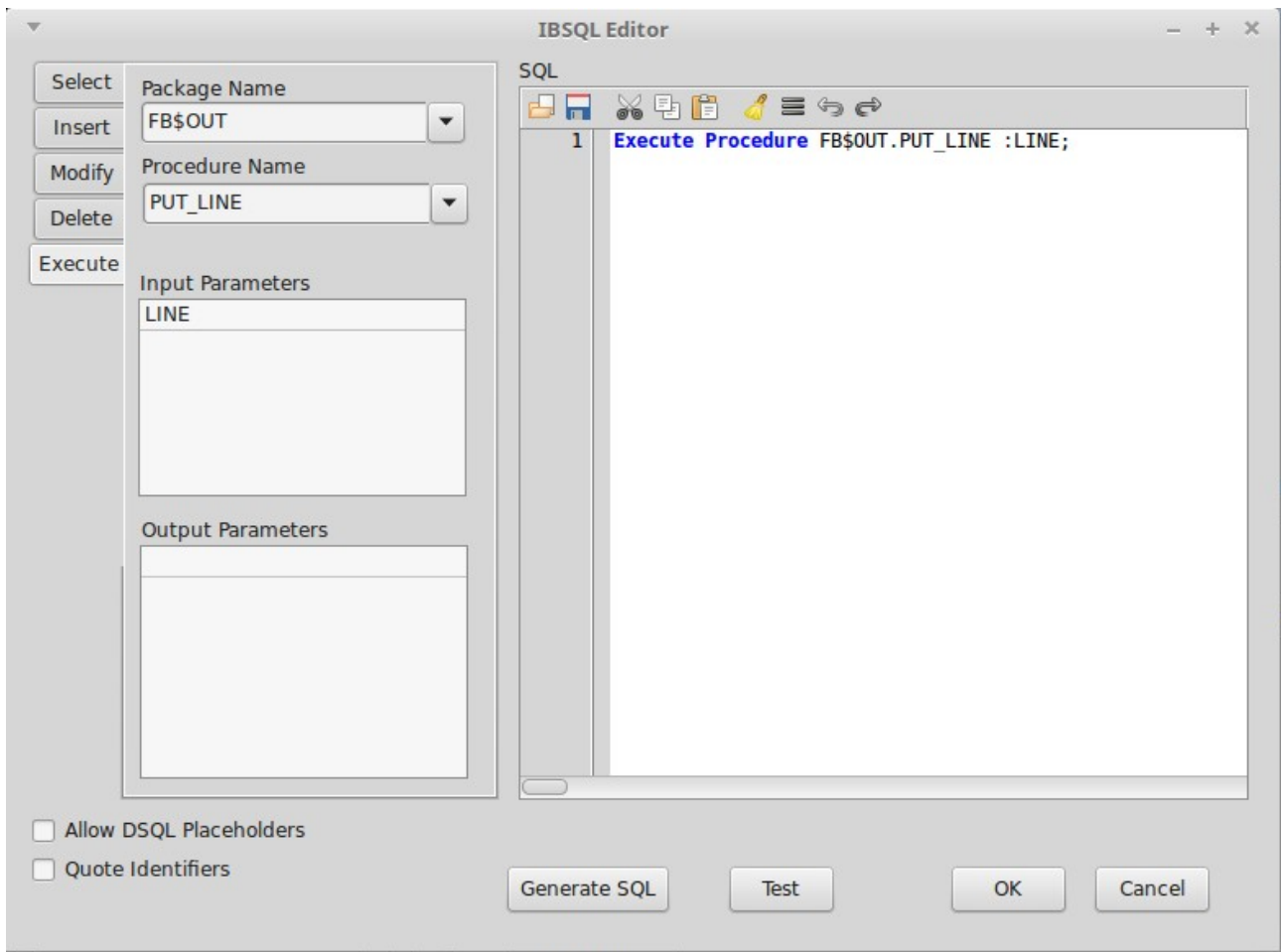

Illustration 5: Using the TIBSQL Property Editor to Generate Execute Statements

5.4.4 Scrollable Cursors

If a scrollable cursor is opened by TIBSQL then the following methods may be used to position the cursor:

- FetchNext may be called to fetch the next record (synonym for “Next”)
- FetchPrior may be called to fetch the previous record
- FetchFirst may be called to fetch the first record in the dataset.
- FetchLast may be called to fetch the last record in the dataset.
- FetchAbsolute may be called to fetch by record number.
- FetchRelative may be called to fetch by the relative record number.

Note: scrollable cursors are only supported for local databases at present (Firebird limitation).

The HasScrollableCursor method may be used to determine if the database connection supports scrollable cursors.

6

The DataSet Components

The TDataSet model introduced with Delphi and re-implemented by Free Pascal provides a common model for accessing datasets and is used by many Lazarus applications. Data aware controls can be placed on a Lazarus form and linked to a dataset via a TDataSource. In most cases, they also link, by name, to a single field² in the dataset. The focus can be placed on a single row in the dataset, and changes made to data in that row by editing the data present in one or more data aware controls. The changes are saved to the underlying database by “posting” the change (i.e. calling the TDataSet.Post method). A Cancel method also exists to undo unposted changes.

TDataSet is an abstract class which provides a common ancestor for many different types of dataset and databases. IBX provides a set of TDataSet subclasses in order to provide efficient SQL based access to data held in Firebird databases. In addition to defining the common view of a dataset, TDataSet also defines common methods for selecting (locate) a specific row in the dataset and moving backwards and forwards through the dataset (First, Last, Next, Prior and MoveBy).

IBX defines an internal class – TIBCustomDataset – which handles most of the details of providing access to a Firebird sourced dataset. However, this is not itself made directly visible and instead a set of derived classes are provided on the Firebird palette as the IBX Datasets.

6.1 IBX Datasets

The IBX Datasets available for use are:

- TIBTable
- TIBStoredProc
- TIBQuery
- TIBDataset

²A dataset is composed of one or more rows of data, organised into columns. A Field is said to be the intersection of a row and a column and is known by the column name. Its value is taken from the current row.

In support of TIBQuery, TIBUpdateSQL provides a means to add or override the SQL used to modify, insert, delete or refresh a dataset.

6.2 Common Concepts

6.2.1 Common Properties

All the IBX TDataset subclasses support the following properties:

Active	At run time, set to true to open the dataset and to false in order to close the dataset. If set at design time then the dataset is opened as soon as the form it is on has completed loading.
AllowAutoActivateTransaction	If this property is set to true then activating the dataset (setting its active property to true) will automatically start the dataset's transaction.
AutoCalcFields	When true, calculated fields determined by table lookup are automatically re-calculated each time the current row changes. This is inherited behaviour from TDataset.
AutoCommit	May be set to "disabled" (default) or to "CommitRetaining". In the latter case whenever a row is deleted or posted, the dataset's transaction is closed with "CommitRetaining" thereby saving the change to the database whilst retaining the transaction context and allowing the dataset to stay open.
BufferChunksInFirstBlock	Default 50: This gives the number of buffers in the initial block for the buffer pool in bi-directional datasets. With most small datasets this should be sufficient to contain all rows. Although this property may be given a higher value for larger datasets, the BufferChunks property applies to all subsequent blocks and its value should be appropriate for larger datasets. See Appendix B.
BufferChunks	Default 1000: This gives the number of buffers in the second and subsequent buffer pool blocks. In most cases, there will probably be no reason to change this value.
CachedUpdates	<p>If true then updates are held locally instead of being written to the database, when changes are posted. Only when the ApplyUpdates method is called are the changes written to the database. The CancelUpdates method can be used to roll back all changes to the last time ApplyUpdates was called.</p> <p>This performs a form of Commit/Rollback without having to write data to the database itself.</p>

Database	A reference to the TIBDatabase managing the connection to the database used for this dataset.
DatasetCloseAction	Set to "DiscardChanges" (default) or "SaveChanges". This determines how the dataset handles a modified but unposted row when the dataset is closed. If "SaveChanges" is selected then the row is posted before closing the dataset. Otherwise, the changes are silently discarded.
Transaction	A reference to the transaction under which the dataset is read from the database and updates are applied.
Unidirectional	If true then the dataset can only be scrolled forwards. Avoids the need to create and maintain a large internal buffer pool (see BufferChunks above).

6.2.2 Common Events

Event handlers may be defined for events trigger before and after the dataset is opened and closed, and before and after rows are inserted, deleted and posted. Similarly for entering the Edit state and cancelling changes, and before and after a transaction end.

BeforeOpen	<p>This is one of the most important event handlers and fires after the dataset Active property is set to true but before it is opened. If the select query that defines the dataset has parameters, this is a good place to set the parameter values.</p> <p>This event handler can also be used to activate datasets that should be open before this one is opened³.</p>
AfterOpen	This event handler can be used to locate the dataset on a specific record. It is also a good place to open datasets that depend on this dataset e.g. in a master/detail relationship.
BeforeClose	Typically used to ensure that datasets that must be closed before this one are closed. e.g. in a master/detail relationship.
AfterClose	Typically used to close datasets that no longer need to be open once this dataset has closed.
BeforeEdit	Raise an exception here if the row should not be edited.
AfterEdit	This handler can be used to set some visual indication that

³When datasets are organised into a dependency hierarchy, if the event handlers are set up correctly, only the top level dataset needs to be explicitly activated. The remainder are then opened in sequence as determined by the event handlers.

	the row is now in the edit state.
BeforeInsert	Raise an exception here if the row should not be inserted at this time
AfterInsert	A good place to set initial values for a newly inserted row.
BeforeDelete	Raise an exception here if the row should not be deleted.
AfterDelete	Could be used to give some visual indication that there are pending changes to be committed (AutoCommit off).
BeforeCancel	Raise an exception here if the changes should not be cancelled.
AfterCancel	This handler can be used to reset the visual indication that the row is in the edit state.
BeforePost	Raise an exception here if the changes should not be posted, perhaps after validation. May also be used to set field values when the field is not managed by a data aware control.
AfterPost	Could be used to give some visual indication that there are pending changes to be committed (AutoCommit off).
BeforeTransactionEnd	Raise an exception here if the transaction should not be completed at this time.
AfterTransactionEnd	Could be used to reset the visual indication that there are pending changes to be committed
OnCalcFields	A TDataset can include additional fields to those retrieved from the database and which are calculated on a per row basis. This event handler is called each time the dataset is scrolled and a new row becomes current. This is where the calculated fields should be refreshed.
BeforeScroll	Called before changing to a different row. Raise an exception here if the row should not be changed.
AfterScroll	Called after changing to a different row. Could be used to update controls from field values when the controls are not data aware.

6.2.3 Exception Handling

An IBX dataset provides several error handling events including `OnDeleteError`, `OnEditError`, `OnPostError`. This may be used to handle database generated exceptions on a per dataset basis. However, it should be noted that all database engine exceptions are raised as `EIBInterBaseError`. A single centralised exception handler set up using `TApplication.AddOnExceptionHandler` and which reports `EIBInterBaseError` exceptions appropriately may be a more efficient approach.

6.2.4 Character Sets and Code Pages

Firebird text fields always belong to one of the supported character sets (e.g. UTF8). From FPC 3.0.0, Pascal AnsiStrings have a code page attribute that identifies the character set used for the string. IBX is designed to ensure that text field character sets and AnsiString code pages are always consistent and to transliterate if necessary when transferring data to and from text fields in a database. See Chapter 9 of the Firebird Pascal API Guide for more information.

6.3 TIBTable

`TIBTable` provides a simple means to access and update a Firebird database table or view without having to have knowledge of SQL. Only the table name needs to be provided and IBX does the rest. `TIBTable` datasets can also be arranged in Master/Detail relationships. See also the example in “`ibx/examples/ibtable`”.

6.3.1 Highlighted Properties

<code>GeneratorField</code>	Specifies the automatic setting of a field from a Firebird generator when a new row is appended to the table. See 6.6.3.
<code>IndexDefs</code>	Allows editing and hence modification of the index definitions for table. Use with the “ <code>StoreDefs</code> ” property.
<code>IndexFieldNames</code>	Used by the “Detail” table in a Master/Detail relation: identifies the fields (as a semi-colon separated list of field names) by which the detail table is joined to the master and also gives the sort order of the detail table.
<code>IndexName</code>	Identifies an index used to sort the table. This property may not be used in a “Detail” table.
<code>MasterFields</code>	Used by the “Detail” table in a Master/Detail relation: identifies the field names in the master table which correspond to the <code>IndexFieldNames</code> .
<code>MasterSource</code>	Used by the “Detail” table in a Master/Detail relation: Identifies the data source for the master table.
<code>MasterDetailDelay</code>	Used by the “Detail” table in a Master/Detail relation: when non-zero, the property value is interpreted as the number of milliseconds to wait between the master dataset being scrolled to a new row and the detailed dataset being closed and re-opened. If the master dataset is scrolled again before the timer expires then the timer is restarted.

	<p>Inserting such a delay can be a useful way of improving performance when the detail dataset is large or takes a long time to open.</p> <p>Note: Ignored in console mode.</p>
StoreDefs	If true then the index defs are stored in the form's lfm file.
TableName	The name of the database table that is the source for the dataset.
TableTypes	Used to control the list of tables names returned from the server at design time. The default list is user tables only. System tables and views can be added to the list by selecting the appropriate options.

6.3.2 Using TIBTable

A TIBTable is arguably the simplest IBX dataset to use – although also limited in capability. To use it simply drop the component on to a form and, in the Object Inspector, link it to a TIBDatabase and then select the required table from the drop down list for the TableName property. When the Active property is set, SQL is automatically generated to read the database table contents into the dataset.

The row order can be varied by selecting an (existing) index on which to sort the data, or giving a list of IndexFileNames in field sort order.

The table is also updateable unless its ReadOnly property is true. The SQL needed to update the database is also automatically generated. If AllowAutoActivateTransaction and AutoCommit are also true then transaction management is fully automated and all changes are automatically saved to the database. You should also select the DatasetCloseAction to SaveChanges. The example program operates in this way, with master data AllowAutoActivateTransaction set to true.

6.3.2.1 Master/Detail Tables

The main limitation of TIBTable is that it is a single table view on the database. The dataset presented must correspond one-to-one with a table or view defined in the database. However, even within these restrictions, it is still possible to use the component to manage tables/views in master/detail relationships.

A Master/Detail relationship occurs when there are fields in common between two tables that allow the tables to be joined together in such a way that one row in the Master table relates to multiple rows in the detail table. For example, one table may be a list of departments, while the other lists employees and the department in which they work. If the table of departments is the master and the employees is the detail, then joining the two on the department name in a master detail relationship means for each row selected in the department table, the employee table lists the employees in that department – whilst excluding the rest.

To set up two tables in a master/detail relationship:

1. Create the two TIBTable components and link them to the same database. In each case, set the required table name.
2. Drop a TDataSource component on to the form and link it to the master table.

3. Link the MasterSource property of the detail table to this data source.
4. Open the Detail Table's MasterFields property editor by clicking on the button next to this property in the Object Inspector (see Illustration 6).

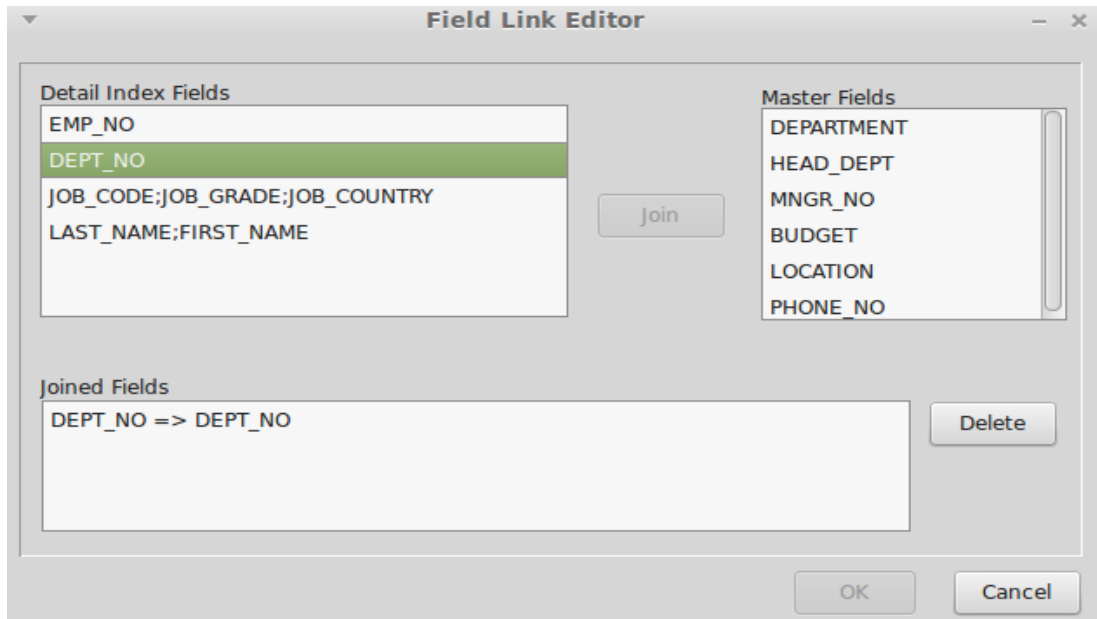

Illustration 6: Master Fields Property Editor

5. The “Detail Index Fields” presents a list of available index field combinations in the detail table (as defined by table indexes in the database). The appropriate index field list on which to make the join should be selected.
6. Now select the corresponding field name(s) in the Master Fields list and click on the “Join” button. The joined fields are now shown below.
7. Click on OK to complete the join.

At run time, you should first activate the Master table and then Detail table. Activating the detail table in the AfterOpen event handler for the Master table is one way of ensuring this. Likewise closing the detail table in the BeforeClose event handler for the Master table.

While the tables are open, selecting a row in the Master table will cause the detail table to be re-opened selecting the detail rows appropriate to the selected master row.

Note, in the `ibx/examples/ibtable` example program, the Master table is activated in the `TIBDatabase AfterConnected` event handler, and the Detail table activated in the Master table's `AfterOpen` event handler.

6.3.2.2 Filtered Datasets

Rather than always returning all rows in the database table, it is possible to filter the dataset returned by a `TIBTable` in order to limit the dataset to only those rows which are of interest. Both server side and client side filters are supported. In order to filter the dataset, the “Filtered” `TIBTable` property must be set to true.

- Server side filters:

This is the most efficient way of filtering a dataset and uses the Firebird server's SQL engine to implement the filter. Server side filters are enabled by setting the SQLFiltered property to true.

The filter is provided as the value of the TIBTable "SQLFilterParams" property and should be a list of valid SQL conditional expressions referencing one or more of the underlying database table's column names. The "Filter" is used when constructing the SQL select statement used to return the dataset and each condition is added (ANDed) to the "where" clause. For example, when the table is the example Firebird employee database and the underlying table is the EMPLOYEES table, then a valid Filter value is "Salary < 10000". The dataset is then filtered to remove all rows with a Salary >= 100000 (see the ibx/examples/ibtable example application for an example of how this is used).

The SQL conditional expression may include IBX style parameter names (see 6.5.4) in which case the parameter values must be set in the TIBTable's "BeforeOpen" event handler.

"SQLFilterParams" is a published property and may be set at design time and/or dynamically modified at run time.

- Client side filters:

Client side filtering uses the "OnFilterRecord" event handler. It is less efficient than server side filtering as the entire table is always returned from the server where unwanted rows are discarded, rather than only returning the rows required (server side filters).

If "Filtered" is set to true and an "OnFilterRecord" event handler is provided then the "OnFilterRecord" event handler is called for each row read from the database. The event handler may inspect the row and column values (e.g. using FieldByName) and determine whether to accept the row into the dataset by setting the "Accept" parameter to true or false as appropriate.

Note: The TDataSet Filtered property is inherited by TIBTable, but is ignored.

6.4 TIBStoredProc

TIBStoredProc is used to execute a stored procedure (on the Database Server), and one that does not generate a results set. It generated the SQL needed to execute the procedure, and hence avoids the programmer having to code this themselves. Advanced users may prefer to use embedded SQL (see 5.1.10) or TIBSQL (see 5.4).

6.4.1 Highlighted Properties

PackageName	Firebird 3 onwards: used to specify the package in which the stored procedure is located. If empty then the stored procedure will be assumed to be defined outside of any package.
StoredProcName	This is the name of the stored procedure in the Firebird database. If the database server is Firebird 3 or later then if PackageName is not empty, the StoredProcName will be assumed to refer to a stored procedure in the specified package.

Params	The list of procedure input and output parameters, if any. Generated from the database.
--------	---

6.4.2 Using TIBStoredProc

At design time:

1. Drop a TIBStoredProc component on your form and select the database.
2. Firebird 3 or later: Set the PackageName property to the package in which the stored procedure is located, if any, by selecting the package name from the drop down list.
3. Set the StoredProcName property in the object inspector by selecting the procedure name from the drop down list. If PackageName is non-empty then the list is restricted to the stored procedures located in the package. Otherwise, the list comprises all stored procedure defined outside of any package.

Note: if you manually enter the value of the StoredProcName then you must ensure that it is in upper case only unless the database is operating under dialect 3 and the stored procedure name was declared by delimiting it in double quotes and is in mixed case or contains special characters e.g.

```
CREATE PROCEDURE "iCASE";
```

In this case, the value of the StoredProcName should be iCASE. The delimiting double quotes must not be present in the StoredProcName.

At run time, and each time you execute the procedure, you may specify any required parameter values using the Params property or ParamByName method, and then execute the procedure using the ExecProc method.

For example:

```
with IBStoredProc1 do
begin
  Transaction.Active := true;
  ParamByName('EMP_NO').AsInteger := 8;
  ExecProc;
end;
```

In the above, it is assumed that the stored procedure has a single integer parameter with the name EMP_NO. Once this is set the procedure may be executed. Note that the parameter names are taken from the stored procedure definition in the database, e.g.

```
Create Procedure MyProc(EMP_NO Integer)
...
```

A stored procedure can also return values as output parameters. These are accessible only by interrogating the Params property to find the output parameter with the required name (again taken from the stored procedure definition in the database).

Note: TIBStoredProc may not be used to execute a stored procedure that returns multiple rows using the SUSPEND command. A TIBQuery or a TIBDataset should be used to execute this type of stored procedure using a select query.

6.5 TIBQuery

This component is a descendent of TDataSet and creates the dataset from the results of an SQL query (Select statement or a Stored Procedure that returns a results set). The SQL query used is given by its SQL property. It is much more powerful than TIBTable as it can generate a dataset from any select SQL statement, joining or processing as many tables as needed. However, it does require some knowledge of SQL to use.

The dataset provided by TIBQuery is read only unless the component is supported by an Update Object.

6.5.1 Highlighted Properties

DataSource	This is an optional link to another dataset that can be referenced for some or all of the values required by a parameterised query. Can be viewed as a more general version of the MasterSource property in a TIBTable.
MasterDetailDelay	Used by the "Detail" table in a Master/Detail relation (i.e. a TIBQuery with a non-empty DataSource property): when non-zero, the property value is interpreted as the number of milliseconds to wait between the master dataset being scrolled to a new row and the detailed dataset being closed and re-opened. If the master dataset is scrolled again before the timer expires then the timer is restarted. Inserting such a delay can be a useful way of improving performance when the detail dataset is large or takes a long time to open. Note: Ignored in console mode.
ForcedRefresh	In an updateable query, this forces each row to be refreshed automatically from the database after it is inserted or updated. Useful for updating computed fields (from the database) and the results that may result from database triggers. Note: An Update/Insert query with a RETURNING clause may be more efficient as it avoids a full select query. Note: The AfterRefresh event is not triggered by a ForcedRefresh. Use the AfterPost handler instead.
GeneratorField	In an updateable query specifies the automatic setting of a field from a Firebird generator when a new row is appended to the dataset. See 6.6.3.
Params	The list of parameters extracted from a parameterised query.
SQL	The query SQL provided as a string list.
UpdateObject	A reference to an optional TIBUpdateObject (see 6.6)

6.5.2 Using TIBQuery

At design time:

1. Drop a TIBQuery component on your form and select the database.
2. Specify the SQL Query by using the SQL property editor opened by clicking on the button next to the TIBQuery's SQL property in the Object Inspector (see 6.5.3).

If the SQL has no parameters then all that needs to be done at run time is to set the component's Active property to true; the query is executed and the results become available as the dataset.

- If the database is not connected when the active property is set to true then it is implicitly opened.
- If the transaction has not been started when the active property is set to true then an exception is raised unless the AllowAutoActivateTransaction property is also true.

The handling of parameterised queries is discussed below in 6.5.4.

Note: the dataset is often restricted to a single row in the select query. This is appropriate for a form used to display/edit a single row of a database table and is much more efficient than reading in an entire dataset just to edit a single row. An example of the use of multi-row datasets is when they are the source for the data aware component TIBDynamicGrid (see Error: Reference source not found).

6.5.3 The Select SQL Property Editor

The Select SQL Property editor provides a means to enter and edit an SQL Query at design time. It also allows the query to be tested for correct syntax. Model queries can also be generated from information sourced from the database.

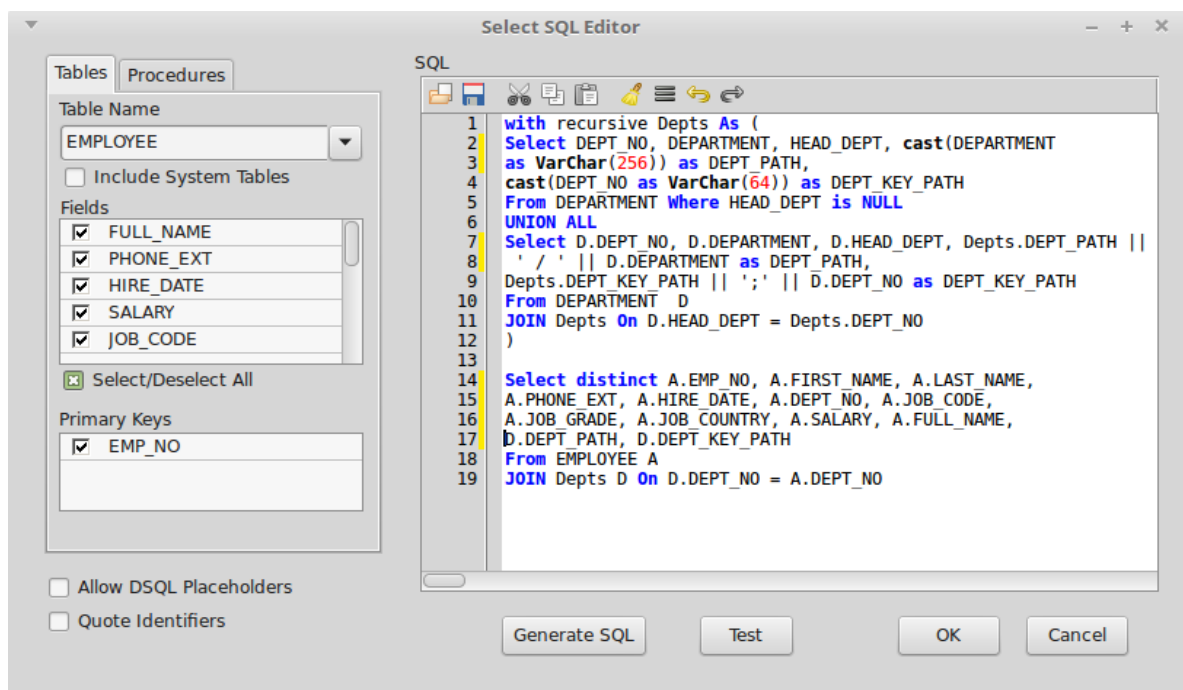

Illustration 7: Select SQL Property Editor

For the editor to function correctly, a TIBDatabase component must be referenced from the TIBQuery and linked to a live database. A default transaction must be present and linked to the TIBDatabase and the Database property must be set for each data access component, and pointing to the TIBDatabase component.

The Select SQL Editor is shown in Illustration 7. The Select SQL Editor is a specific case. IBX SQL Editors also exist for Refresh, Update, Insert and Delete SQL.

All of IBX's SQL editors follow the same basic scheme with a combo box in the left hand frame listing available tables and listboxes showing the columns and Primary Keys respectively for the currently selected table. This can be used both for reference purposes and as a source for the Generate SQL function. The Insert and Modify property editors additionally show the "Computed By Columns" in a separate list, and the Insert Property editor has a further list for "Identity Columns" (see 6.6.8).

- A "Generate SQL" button causes a Select, Insert, Update or Delete Statement, as appropriate, to be generated for the currently selected table, and presented into the right hand editor window. If one or more columns are selected then the statement is restricted to those columns, otherwise all columns are included in the statement.

Note that in the Modify SQL Property Editor, Update statements may be restricted to avoid updating the primary key values. If these are internal keys that are not visible to the user, then there is little value in including them in the update statement. Computed By columns are refreshed after the update using the UPDATE...RETURNING clause.

Note: The Insert SQL Property Editor separately lists Identity Columns. When SQL is generated, these are not included in the list of fields to be inserted. However, a RETURNING clause is added to return the assigned values of these columns.

- Double-clicking on a table or column name will cause that name to be inserted in the SQL statement.
- The "Test" button can be used to validate the current SQL statement. The error generated by the database engine, if any, will be shown to the user.

In typical use, the "Generate SQL" function provides an initial set of SQL statements that can be edited to suit the actual purpose. The "Test" function can be used to check correct syntax and avoids having to compile and run the program in order to test SQL syntax correctness.

The "Quote Identifiers" option places double quotes around all Field and Table Names.

The "Allow DSQL Placeholders" option allows the use of the "?" placeholder in parameterised queries (see below).

SynEdit with SQL syntax highlighting is used to edit the statement. A toolbar and a right click popup menu are also included for common operations including manually initiated wrap on SQL token boundaries in order to display the entire text in the width of the current window.

Note: all SQL Property editors are sizeable using the mouse.

A Select SQL Statement is normally generated from tables and views. However, stored procedures that return a dataset are also a potential source. Hence the tab available for a list of suitable stored procedures (see Illustration 8).

In the Procedures tab, a drop down list of stored procedures is given. This list is restricted to stored procedures that use the "SUSPEND" command to return multiple rows and which have output parameters. The generated SQL is a select statement, but which may (as illustrated) have an input parameter to the stored procedure (see also 6.5.4).

From Firebird 3 onwards, SQL Property Editors now include a "Package Name" drop down box to allow selection of a Firebird 3 Package from which a stored procedure can be selected. With no package name selected, non-package stored procedures are listed, otherwise, the list is restricted to stored procedures in the selected package.

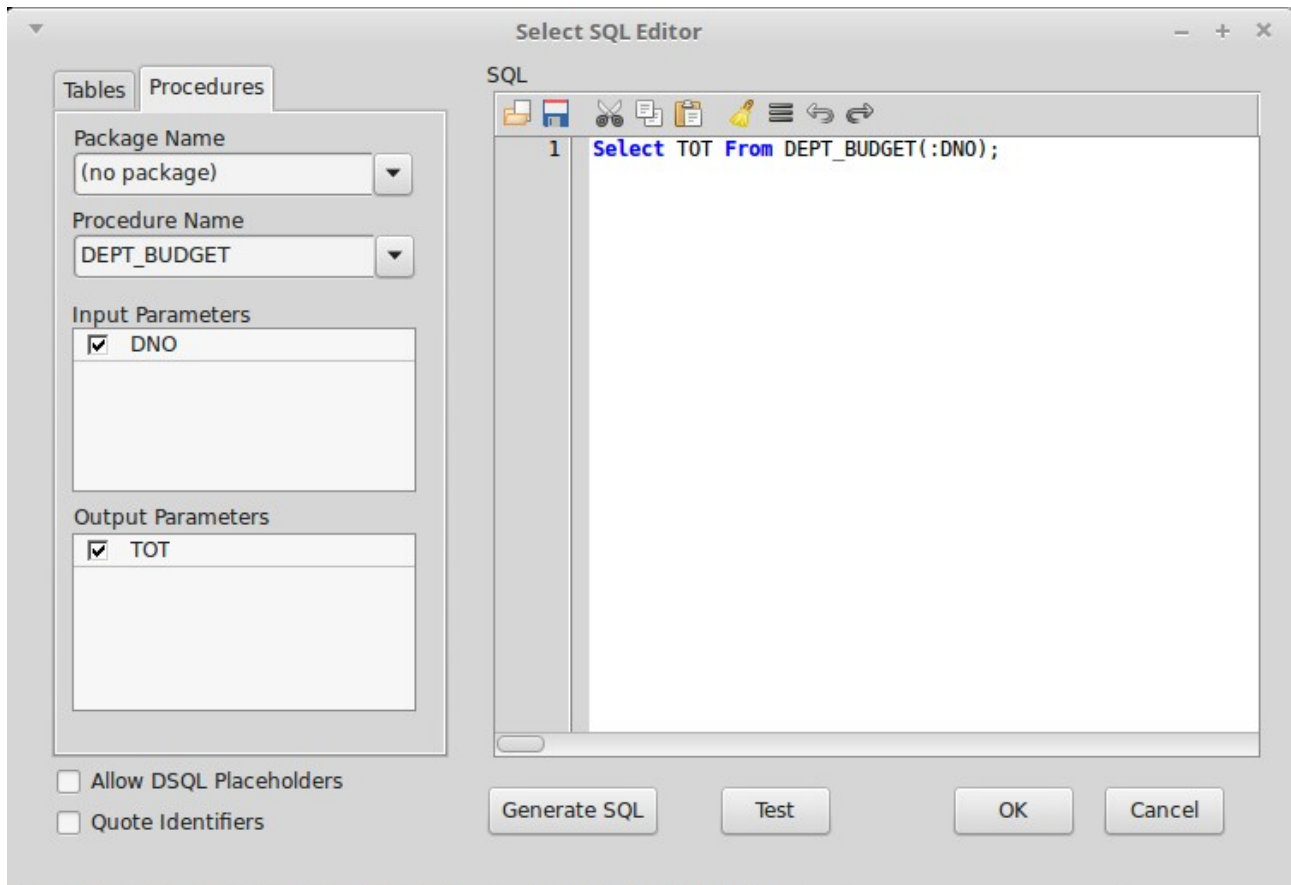

Illustration 8: Select Query from a Stored Procedure

6.5.4 Parameterised Queries

In this context, a parameterised query is an SQL statement given as the value of a TIBQuery's SQL property and which has (named) parameter placeholders included in the statement.

The SQL statement syntax supported by IBX is the same as the Dynamic SQL syntax supported by Firebird. Both the Data Manipulation Language (DML) and the Data Definition Language (DDL) can be used. However, there is one important difference and that is in the handling of parameterised queries. `ibnongui.lpk`

In normal Firebird Dynamic SQL, query parameters are represented by a '?' placeholder and are manipulated as positional parameters. IBX does allow this approach to be used but also borrows from the Firebird Procedure and Trigger Language and additionally allows the use of named

parameters, where a parameter name starts with a colon character and otherwise conforms with the requirements for a database column name. For example:

```
Select A.EMP_NO, A.FIRST_NAME, A.LAST_NAME, From EMPLOYEE A
Where A.EMP_NO = :EMP_NO;
```

is a parameterised select query where “:EMP_NO” is a parameter. This enhancement is essential for support of update objects (see 6.6). The actual implementation of parameterised queries is supported by the *fbintf* package. See section 6.1.1 of the Firebird Pascal API Guide.

For a select query, the parameter value must be specified before the query is activated. For example:

```
IBQuery1.ParamByName('EMP_NO').AsInteger := 1;
IBQuery1.Active := true;
```

If a TIBQuery with a parameterised Select query is activated without a parameter value assigned, and the query has a DataSource property set, the component will query the Dataset linked to DataSource, provided that it is already active. If it has a field with the same name as the parameter (leading ':' omitted) then the current value of the field is taken as the parameter value. This allows master/detail relationships to be simply established by careful choice of parameter names.

In practice, the TIBQuery's BeforeOpen event handler is a good place to set any parameter values that are not automatically set from a DataSource. Placing them here ensures the parameter values are always set before the dataset is opened.

6.5.5 Filters

Proir to IBX 2.3.3, TIBQuery only supported client side filtering using the “OnFilterRecord”. From IBX 2.3.3 it also supports server side filtering using the “SQLFilterParams” property. Both client and server side filtering have already been described in 6.3.2.2 for TIBTable. Since IBX 1.2, TIBQuery has also supported dataset filtering using the TSelectSQLParser (see 7.3).

The TIBQuery implementation of server side filtering also uses the TSelectSQLParser and is compatible with general use of the TSelectSQLParser. In practice, when the “SQLFiltered” property is true, the list of conditions provided by the “SQLFilterParams” property provides additional element sof the select query “Where” clause ANDed with any “Where” clause in the original select query. The result of this may be further manipulated using the “Parser” property as described in 7.3.

If only a simple filter (SQL conditional statement) is required then use of the “SQLFiltered” property is probably sufficient and the more general approach described in 7.3 can be avoided.

Note: The TDataSet Filtered property is inherited by TIBTable, but is ignored.

6.6 Update Objects

TIBQuery on its own only provides a read only dataset. If the dataset is to be updateable then a TIBUpdateSQL or TIBUpdate must also be placed on the form and set as the value of the TIBQuery's UpdateObject property.

6.6.1 TIBUpdateSQL

The TIBUpdateSQL provides the Modify, Insert, Delete and Refresh SQL statements needed to make the dataset updateable.

6.6.1.1 Highlighted Properties

RefreshSQL	A StringList that defines an SQL Statement used to refresh a single row in the dataset (see 6.6.9).
ModifySQL	A StringList that defines an SQL Statement used to update a single row in the database from updated field values in the current row of the dataset. (the UPDATE... RETURNING clause is supported see 6.6.1.4)
InsertSQL	A StringList that defines an SQL Statement used to insert a single row into the database from field values in the current row of the dataset (the INSERT... RETURNING clause is supported see 6.6.1.4)
DeleteSQL	A StringList that defines an SQL Statement used to delete a single row in the database corresponding to the deleted (current) row of the dataset.

Property editors are available for each of the above and follow the same pattern as for the TIBQuery SQL property editor. The TIBUpdateSQL component editor provides access to all four of the above in one dialog.

6.6.1.2 SQL Syntax for Update Object Queries

Note: from IBX 2.2.0 onwards, Insert and Update SQL may contain a RETURNING clause (see 6.6.1.4).

Each of the SQL Statements given in an UpdateObject are parameterised queries:

- A Refresh SQL query is a select SQL Query very similar to the TIBQuery's SQL statement except that includes a "where" clause that restricts the query result to a single row: the row that corresponds to the current row of the dataset (typically using the Primary Key as the select criteria). e.g.

```
Select A.EMP_NO, A.FIRST_NAME, A.LAST_NAME, A.PHONE_EXT, A.HIRE_DATE,
       A.DEPT_NO, A.JOB_CODE, A.JOB_GRADE, A.JOB_COUNTRY, A.SALARY,
       A.FULL_NAME From EMPLOYEE A
Where A.EMP_NO = :EMP_NO
```

- A Modify SQL query is an update SQL statement that updates a single row in the database using the current dataset row as its data source (note the use of the :OLD_ convention for a last parameter -see 6.6.1.3) e.g.

```
Update EMPLOYEE A Set
  A.EMP_NO = :EMP_NO,
  A.FIRST_NAME = :FIRST_NAME,
  A.LAST_NAME = :LAST_NAME,
  A.PHONE_EXT = :PHONE_EXT,
  A.HIRE_DATE = :HIRE_DATE,
  A.DEPT_NO = :DEPT_NO,
  A.JOB_CODE = :JOB_CODE,
  A.JOB_GRADE = :JOB_GRADE,
  A.JOB_COUNTRY = :JOB_COUNTRY,
```

```
A.SALARY = :SALARY
Where A.EMP_NO = :OLD_EMP_NO
RETURNING FULL_NAME
```

- An Insert SQL query is an insert SQL statement that inserts a single row into the database using the current dataset row as its data source. e.g.

```
Insert Into EMPLOYEE(EMP_NO, FIRST_NAME, LAST_NAME, PHONE_EXT,
    HIRE_DATE, DEPT_NO, JOB_CODE, JOB_GRADE, JOB_COUNTRY, SALARY)
Values(:EMP_NO, :FIRST_NAME, :LAST_NAME, :PHONE_EXT, :HIRE_DATE, :DEPT_
    NO, :JOB_CODE, :JOB_GRADE, :JOB_COUNTRY, :SALARY)
RETURNING FULL_NAME
```

- A Delete SQL query is a delete SQL statement that deletes a single row from the database using the current dataset row as its data source. e.g.

```
Delete From EMPLOYEE A Where A.EMP_NO = :EMP_NO
```

In each of the above, named parameters are used with the convention that parameter names correspond to field names in the dataset. This convention is then interpreted to mean that when the query is executed, the parameter value is taken from the field in the current row with the same (alias) name.

- In the Refresh query, the “where” clause should always use one or more fields to select the row that have a combination of values that is unique to that row. Typically the fields that make up the primary key for the underlying table. If the query returns multiple rows, only the first is used to refresh the current row.
- In the update query, each field in the database is updated from its corresponding field in the current row. However, note the “OLD_” convention used in the “where” clause. This is discussed below in 6.6.1.3. Otherwise, it should select the corresponding row in the database similar to the refresh statement.
- In the insert query, each field in the database is also updated from its corresponding field in the current row.
- In the delete query, the “where” clause selects the row in the database to be deleted and should be identical to the “where” clause in the refresh statement.

In both INSERT and UPDATE queries, the “COMPUTED BY” column FULL_NAME is returned by the query and updates the corresponding field. There is thus no need to refresh the dataset to get the up-to-date value of this field which changes when (e.g.) LAST_NAME changes (see Firebird's example employee database). See also 6.6.1.4.

6.6.1.3 OLD and NEW Parameters

These are typically used in Modify SQL statements. For example, when the primary key value is changed. In this case, the row to be updated needs to be selected by the original value of the primary key, while the field(s) that corresponds to the primary key needs to be set to the new value. In order to support this capability, IBX allows parameter names to be prefixed by "OLD_" and "NEW_" where the former references the fields value when it was last read from the dataset (i.e. before a call to TDataset.Edit), while the latter is the default and refers to the modified value set after a call to TDataset.Edit. For example, specify an Update SQL statement in the form:

```
UPDATE MYTABLE Set Key1 = :NEW_KEY1, COL2 = :COL2 Where Key1 = :OLD_KEY1;
```

to correctly handle database updates such as:

```
IBDataset1.Next;
IBDataset1.Edit;
IBDataset1.FieldByName('key1').AsInteger := <a new value>;
IBDataset1.Post;
```

Note that as `NEW_` is the default, it does not need to be used unless the objective is to be explicitly clear.

The “`OLD_`” convention can also be used for setting field values in an update statement where there is a need to preserve the previous value (e.g. in a different field). For example:

```
Update EMPLOYEE A Set
  A.EMP_NO = :EMP_NO,
  A.LAST_NAME = :LAST_NAME,
  A.PREVIOUS_NAME = :OLD_LAST_NAME,
Where A.EMP_NO = :OLD_EMP_NO
```

The “`OLD_`” convention should not be used with `Refresh` as refresh cannot be used unless the dataset is in “browse” mode i.e. the current row is not being edited or inserted. Delete queries should normally use the current value for the key rather than the old value.

6.6.1.4 Insert and Update Returning Clauses

From Firebird 2.1 onwards, Firebird supports Insert and Update Queries with “`RETURNING`” clauses. After the query has been executed, this clause allows the query to return the current values for the named columns. From IBX 2.2.0 onwards, IBX updateable datasets support Insert and Update Queries with “`RETURNING`” clauses by:

- Once the query is executed a check is made for any returned values.
- For each returned value, the name of the returned value (its alias name) is matched against the list of alias names for the dataset columns.
- If a match is found then the returned value replaces the current value for that column in the current row.

Note: if, for some reason, the data type of the returned data is incompatible with the data type of the column, then an exception is raised.

6.6.1.5 Delete Returning Clauses

`DELETE...RETURNING` queries are also recognised. However, as they are called when the dataset row is being deleted, there is no value in updating the current record from the query result. Instead, an event handler `OnDeleteReturning` is provided. If a `DELETE...RETURNING` query is execute and an `OnDeleteReturning` event handler is provided then it is called with the `IResults` returned by the query. The event handler can then interrogate the query results and perform whatever action is necessary. For example to confirm, to the user, the deletion of a row with the returned values.

6.6.1.6 Using Stored Procedures for Insert, Update or Delete

It is possible to specify a Stored Procedure for an Insert, Update or Delete SQL if this results in the correct semantic i.e. row insertion, update or delete. In this case, the “Execute Procedure” syntax is used with the procedure input parameters expressed in the same (leading ':') syntax as used for parameterised queries. E.g.

```
Execute Procedure MyProc :Arg1, :Arg2
```

Stored procedures executed in this way can return a singleton row of output parameters (if the procedure definition includes output parameters). If available, these are always returned. The output parameters, if any, are treated in the same way as INSERT...RETURNING or UPDATE...RETURNING outputs. They are scanned after the stored procedure is executed and for each output parameter name that matches the aliasname of dataset field, the value of the output parameter is used to update the corresponding field in the current row.

6.6.2 TIBUpdate

This component can also be linked from a TIBQuery component and is a more general way to support updateable queries than that provided by TIBUpdateSQL. While TIBUpdateSQL supports single SQL statement for Delete, Update or Insert, TIBUpdate provides an event handler for Update, Insert or Delete together with an ISQLParams interface providing access to all current and “old” field values. This gives the programmer complete freedom as to how the Update, Insert or Delete is performed.

Examples of use include:

- Updating a dataset listing user privileges and roles, with Update, Insert and Delete translated into one or more Grant and Revoke statements.
- Implementing a writeable view programmatically rather than through triggers. This may be necessary when a schema update to add triggers to (e.g.) an existing view is not permitted, or when access to information not readily available at the trigger level is required.
- Filtering of dataset updates including silent discard of updates.

An example of the use of TIBUpdate to support Firebird 3 User Management (e.g. with multiple security databases) is available in examples/FB3UserManager.

6.6.2.1 Highlighted Properties

RefreshSQL	A StringList that defines an SQL Statement used to refresh a single row in the dataset.
DataSet	A read only property referencing the dataset being updated.
OnApplyUpdates	This event is called in response to the dataset posting an Update, Insert or Delete action. The event handler is provided with the: <ul style="list-style-type: none"> • Update action requested (Update, Insert or Delete), and • An ISQLParams interface giving access by name to all field values: both current and “old” values. The “old” values (i.e. prior to the update) are accessed by prefixing the field name with

	“OLD_”. All accesses by name are case insensitive.
--	--

6.6.3 Generators

A Firebird Generator (known also as a Sequence) is used to generate a unique sequence number independent of transactions. A typical use is to generate a new primary key for a table which is guaranteed to not clash when another user also adding a record to the same table.

A new generated sequence number is often required when a new row is added to a dataset and the field used for the record key should be set to this sequence number. IBX supports this for updateable datasets when appending or inserting new rows, and through the dataset's `GeneratorField` property.

To specify a generator and the linked field, at design time, open the `GeneratorField` property editor by clicking on the button next to the property in the Object Inspector. The property editor should then appear.

Note: this property is part of the dataset (e.g. `TIBQuery`) and not the update object.

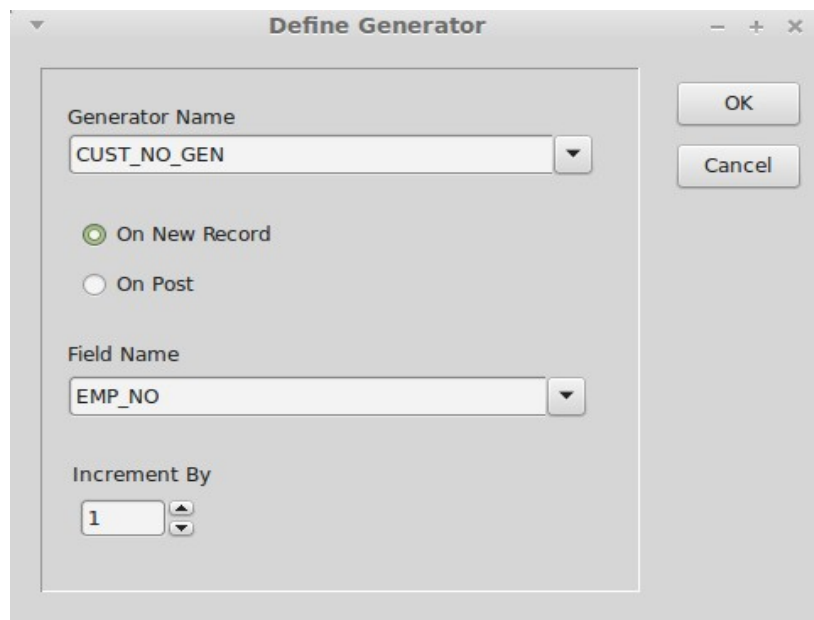

Illustration 9: Define Generator Editor

You may then select the generator from those available in the database and the dataset's field that is to be set from the generator. The field can be set either when the record is inserted or when it is posted. In most cases “On New Record” is appropriate. “On Post” is only really useful when the field is set in a “just in time” manner i.e. to avoid unused sequence numbers.

6.6.4 Updating Datasets

The following rules apply:

1. Only the current row can be modified at any one time.

2. Before a row can be modified, the dataset must be placed into the edit state by calling the `Edit` method.

Note that data aware controls usually call the “Edit” method automatically whenever the data they present is modified.

3. A new row can be added by calling the `Append`, `AppendRecord`, `Insert` or `InsertRecord` method. The dataset then enters the “insert” state.
4. Changes are written to the database by the `Post` method. This can be used whenever the dataset is in the “edit” or “insert” state. On completion, the dataset returns to the “browse” state.
5. Changes can be abandoned (before a post) using the `Cancel` method.

Note that enabling `ForceRefresh` is useful whenever the dataset includes dependent fields in the query (e.g. from a “JOINED” table) and ensures that the dataset presented is always consistent with the data in the database.

6.6.5 Automatic Posting

An updateable IBX dataset will automatically post a modified record when scrolling between rows. When the dataset is closed, the behaviour depends on the setting of the `DataSetCloseAction` property:

- If set to discard changes (the default) a modified record is “cancelled” and the changes lost.
- If set to save changes, the modified record is “posted” before the dataset is closed. The exception is when the dataset is closed due to transaction rollback when the changes are discarded.

6.6.6 The `OnValidatePost` Event

```
TOnValidatePost = procedure (Sender: TObject; var CancelPost: boolean) of object;
```

This event is available for all updateable datasets and is called as the first action in the `Post` method. If it returns with “CancelPost” set to true, then the “Cancel” method is called and the “Post” terminated. The event handler can thus decide if the `Post` should be cancelled by checking the actual field values, even prompting the user to decide.

In terms of event sequencing, the event occurs before an `OnBeforePost` Event. Thus when the dataset is scrolled and the current record is in the “modified” state, then the following events will occur:

- `OnValidatePost` (returns `CancelPost = false`)
- `OnBeforePost`
- `OnAfterPost`
- `OnBeforeScroll`
- `OnAfterScroll`

or

- `OnValidatePost` (returns `CancelPost = true`)
- `OnBeforeCancel`
- `OnAfterCancel`

- OnBeforeScroll
- OnAfterScroll

Note that trying to call “Cancel” in an OnBeforePost handler does not work as the Post still proceeds and, in IBX, an error will be reported.

An exception could be raised in either the OnValidatePost handler or in the OnBeforePost handler to report an actual error in the data.

6.6.7 Cached Updates

If an updatable dataset's `CachedUpdates` property is set to true then updates are cached rather than written through to the database when `Post` is called. Instead, they are only written to the database when the `ApplyUpdates` method is called. This method flushes the cache and writes the changes to the database. Alternatively, the `CancelUpdates` method also flushes the cache but discards the changes instead of writing them to the database; the original row values are restored.

Note that if `DatasetCloseAction` is set to `Save Changes` then `ApplyUpdates` is automatically called after any pending change has been posted.

Cached updates are often very useful when a form is used to edit a multi-row dataset. In this case, the updates need only be written to the database when the form is closed with a `ModalResult` of `mrOK`. If it is closed with `mrCancel`, then `CancelUpdates` may be called and the changes are not written through to the database.

The same effect could be achieved with transactions, but this may not be always as useful or efficient.

6.6.7.1 Cached Updates using OnUpdateRecord

Cached updates can be filtered or performed by an external function (to IBX) by assigning an `OnUpdateRecord` event handler. This has the signature:

```
TIBUpdateRecordEvent = procedure(DataSet: TDataSet; UpdateKind: TUpdateKind;
                                var UpdateAction: TIBUpdateAction) of object;
```

The `ApplyUpdates` method will cycle through all modified, inserted or deleted records in the record cache in turn. For each one, it will call the `OnUpdateRecord` event handler specifying the `UpdateKind` as `ukModify`, `ukInsert` or `ukDelete` respectively and expecting the event handler to return with an appropriate `UpdateAction` specified.

When `OnUpdateRecord` is called, the current dataset record is set to the row for which an `UpdateAction` is requested and hence the `OnUpdateRecord` event handler can determine the field values for this row by using `TDataSet.Fields` or `TDataSet.FieldName` as normal.

On return, the `UpdateAction` must be set to one of the following:

<code>uaFail</code>	<code>ApplyUpdates</code> terminates with a user abort error.
<code>uaAbort</code>	<code>Sysutils.Abort</code> is called
<code>uaSkip</code>	The current record is skipped by <code>ApplyUpdates</code> and remains in the cache with its cache status unchanged i.e. as a modified, inserted or deleted record.

uaRetry	The OnUpdateRecord event handler will be recalled.
uaApply	The updated should be applied by IBX.
uaApplied	The OnUpdateRecord handler has performed the database update itself. Note: returning uaApplied without actually performing the update will leave the dataset out of sync with the database.

6.6.7.2 The OnUpdateError Event

The OnUpdateError event is called when an exception is raised within IBX when a cached update is applied. Its signature is:

```
TIBUpdateErrorEvent = procedure(DataSet: TDataSet; E: EDatabaseError;
                                UpdateKind: TUpdateKind; var TheUpdateAction: TIBUpdateAction)
                                of object;
```

The event handler should return uaFail, uaAbort or uaSkip. uaFail causes the exception to be re-raised while the other two have the same semantics as above. Any other response causes the exception to be ignored and may leave the dataset out of sync with the database.

6.6.8 Identity Columns

Firebird 3 has introduced the Identity column, where an identity column is a column associated with an internal sequence generator. Its value is set automatically when the column is omitted in an INSERT statement.

IBX supports Identity columns by support of the INSERT ... RETURNING clause (see 6.6.1.4). When an Identity column is used (e.g. to generate a unique integer for a primary key), the Insert statement in a TIBUpdateSQL should not include the column in its list of inserted values. Instead, the Identity column should be named in the RETURNING clause.

For example, if a simple example table is defined as:

```
CREATE TABLE ITEST
(
  MYKEY integer GENERATED BY DEFAULT AS IDENTITY,
  SOMETEXT varchar(64),
  PRIMARY KEY (MYKEY)
);
```

then an appropriate Insert SQL would be:

```
Insert Into ITEST(SOMETEXT)
Values(:SOMETEXT) RETURNING MYKEY;
```

When IBX executes the above Insert statement, the current value of the "SOMETEXT" column is inserted into a new dataset row and the value of the KEY column is set (by Firebird) to the next value returned from the corresponding generator. Once the statement has been executed, IBX reads the returned value of the MYKEY column and replaces the current value of the MYKEY field (NULL) with the returned value i.e. the value inserted into the new row.

When using IBX with an Identity column, you should note the following:

- The Identity column should not be included in the Insert SQL list of inserted values.
- The Identity column should be included in the values returned by the Insert statement's RETURNING clause.
- Until a new dataset row has been posted, the value of the Identity column in the current row is null. This is true between executing TDataset.Append and TDataset.Post.
- The generated value of the Identity column is available from the TDataset.AfterPost event handler onwards.
- **Cached Updates:** the value of an Identity column is only known once the row has been inserted into the database table, hence when cached updates are used, any Identity columns in newly inserted rows remain null until "ApplyUpdates" is called and the cached updates are applied to the database. After a call to "ApplyUpdates" the Identity Column values are set to the value assigned by Firebird.

The IBX InsertSQL property editor generates an Insert SQL statement compatible with the above.

An example of the use of Identity columns is provided in examples/IdentityColumn.

6.6.9 Row Refresh

The Refresh Query is used to refresh the current row by executing (typically) a select query that returns the current value of all fields in the row from the database. A refresh is used to ensure that the row is up-to-date and in sync with the database. It is often used to return the values of computed by fields after a row is posted.

Prior to IBX 2.6.0, the TDataset.Refresh method could be called to explicitly perform a row refresh. However, this was not in agreement with Delphi or the FPC Manual which states:

"Refresh posts any pending edits, and refetches the data in the dataset from the underlying database, and attempts to reposition the cursor on the same record as it was. This operation is not supported by all datasets, and should be used with care."

From IBX 2.6.0, TDataset.Refresh complies with the FPC Manual.

A row Refresh is performed immediately after an inserted or updated row is posted and a Refresh Query is present, and:

1. A Field is present in the dataset with the Provider Flag *pfRefreshOnInsert* set and the row had been inserted, or
2. A Field is present in the dataset with the Provider Flag *pfRefreshOnUpdate* is present and the row had been updated, or
3. The Dataset's ForcedRefresh property is true, or
4. The dataset's select query contains read only (computed by) fields and the Insert, or Update query used to update the database did not return the value of any such field.

5. The dataset has blob and/or array fields and the Insert, or Update query used to update the database did not return the value of any such field.

In general, using INSERT...RETURNING or UPDATE...RETURNING is a more efficient way of returning the updated value of fields than is a row refresh (which involves executing a select query) and is hence preferred.

Prior to IBX 2.2.0, INSERT...RETURNING and UPDATE...RETURNING was not supported and hence a row refresh was always performed after an inserted or updated row was posted to the database when the dataset fields contained read only (computed by) fields.

The ForcedRefresh property can always be used to ensure a row refresh after an inserted or updated row has been posted regardless of whether INSERT...RETURNING or UPDATE...RETURNING is or is not used.

Note: the AfterRefresh event is only called when a refresh is performed by a call to TDataset.Refresh.

When cached updates are used, the database is only updated when the TDataset.ApplyUpdates method is called. Hence, with cached updates, the insert or update query is only called from TDataset.ApplyUpdates and not from TDataset.Post and, consequentially, row refresh is only performed, as above, during the processing of TDataset.ApplyUpdates.

Note: cached updates may not be appropriate when the application demands that a dataset row is up-to-date immediately after a TDataset.Post.

6.7 TIBDataSet

The TIBDataSet is TIBQuery and TIBUpdateSQL rolled into one. It defines an updateable dataset and in a single object. All of the above applies.

6.7.1 Highlighted Properties

SelectSQL	A StringList that defines a select SQL Statement used to define the dataset.
RefreshSQL	A StringList that defines an SQL Statement used to refresh a single row in the dataset.
ModifySQL	A StringList that defines an SQL Statement used to update a single row in the database from updated field values in the current row of the dataset.
InsertSQL	A StringList that defines an SQL Statement used to insert a single row into the database from field values in the current row of the dataset
DeleteSQL	A StringList that defines an SQL Statement used to delete a single row in the database corresponding to the deleted (current) row of the dataset.

A component editor is also available for TIBDataset. This is accessed by right clicking on the component once it has been placed on the form. The component editor allows all five SQL statements to be generated with a single click.

6.8 Dataset Fields

The TDataSet model introduces both FieldDefs and Fields where:

- a FieldDef (base class TFieldDef) is created for each column in a dataset and defines various properties including the data type and size. Under IBX, the FieldDef is created from the underlying select query metadata.
- A Field (base class TField) is either dynamically created for each column when the dataset is opened or is created at design time as a published property of the Form on which the dataset is placed, and bound to the dataset column when the dataset is opened. The Field provides the interface between the dataset column and the dataset user and all data access and modification is performed through a Field. Fields are created from the FieldDefs.

6.8.1 FieldDefs

IBX subclasses TIBFieldDef from TFieldDef in order to hold extended Firebird specific information about each database column. This information is available as the following properties:

CharacterSetName	Applies to string and Blob string fields and gives the Firebird character set name of the string's character set.
CharacterSetSize	Applies to string and Blob string fields and gives the maximum number of bytes in each character.
CodePage	Applies to string and Blob string fields and gives the AnsiString code page associated with the column's Firebird Character Set.
DataSize	The maximum number of bytes required to hold data in this column.
RelationName	The Firebird Table Name in which the column is located, if any.
ArrayDimensions	Applies to array columns only and gives the number of dimensions in the array.
ArrayBounds	Applies to array columns only and gives the bounds for each dimension.
IdentityColumn	Applies to integer and numeric columns only and is set to true if the underlying column is an "Identity Column".

The FieldDefs can be accessed using the TDataSet.FieldsDefs property. This returns a list of FieldDefs of type TFieldDef. For IBX Datasets these may be cast to TIBFieldDef in order to access the extended properties.

6.8.2 Field Subclasses

The FCL defines several TField subclasses (e.g. TStringField). Each is specialised to a specific column data type. When the fields are created from a FieldDef, the data type of the column is used to determine the actual TField subclass that is created for the field. IBX also introduces additional TField subclasses in order to support specialised behaviour.

The mapping between SQL Column types and TField subclasses is given in the table below. The IBX specific subclasses are presented in 6.8.3.

SQL Type	TField Subclass	Notes
VarChar, or Char	TIBStringField	See 6.8.3.2
Float or Double	TfloatField	
Integer	TIBIntegerField	
Smallint	TIBSmallIntField	
Bigint	TIBLargeIntField	
Numeric or Decimal	TIBBcdField or TFmtBCDField	Unless defined with zero decimal places when an integer type is used. TfmtBCDField is used for Firebird 4 extended Numeric precision
DecFloat or INT128	TfmtBCDField	Firebird 4 only
Date	TdateTimeField	
Time	TIBTimeField	
Time with Time Zone	TIBTimeField	Firebird 4 only
Timestamp	TIBDateTimeField	Firebird 4 only
Timestamp with Time Zone	TIBDateTimeField	Firebird 4 only
Blob	TBlobField or TIBMemoField	TIBMemoField is used for Blob sub type 1 (i.e. text blobs)
Arrays	TIBArrayField	Regardless of the data type of the array element

6.8.3 IBX Fields

IBX defines several extended TField subclasses (e.g. TIBStringField is subclassed from TStringField) in order to provide extended functionality and to make available Firebird specific column properties.

A field is typically accessed using the TDataSet.FieldName method or, for fields created at design time as Form properties, by the corresponding identifier name given to the Form property.

6.8.3.1 TIBBCDField, TIBSmallIntField, TIBIntegerField and TIBLargeIntField

These are subclasses of the corresponding FCL classes and provide the additional property:

IdentityColumn	Set to true if the underlying column is an "Identity Column" (see 6.6.8).
----------------	---

6.8.3.2 TIBStringField

This is a subclass of TStringField. It's primary responsibility is to ensure that the ANSI code page assigned to strings read from the database matches the Firebird character set of the text string returned by the database. For strings written to the database, it compares the ANSI code page of the string with the Firebird Character set specified for the column and transliterates the string if necessary to that expected by Firebird.

It also provided the following properties:

CharacterSetName	The Firebird character set name of the string's character set.
CharacterSetSize	The maximum number of bytes in each character.
CodePage	The AnsiString code page associated with the Firebird Character Set.
AutoFieldSize	By default true. It is applicable for Fields created at design time as Form properties. When, at run time, the dataset is opened and the field is bound to the dataset column, if true then the column data size provided by the database over-writes that specified at design time. If false then the design time value is used. It is very rare that AutoFieldSize is not set to true. If the value set at design time is too small then this could lead to memory corruption.

6.8.3.3 TIBMemoField

This is subclass of TMemoField and is used for text blobs (see also 8.1.1). It is similar to TIBStringField in that it also manages string code pages and provides for automatic transliteration of strings written to the database.

Additionally, it also allows for automatic string truncation when the contents is retrieved as "DisplayText". This is the case when, for example, a blob string is the source for a column of a

TDBGrid. When a TIBMemoField's contents is retrieved as DisplayText then, depending on its DisplayTextAsClassName property:

- The text returned is the field's classname enclosed in brackets (FCL default).
- The text returned is the contents of the field truncated, if necessary, to the number of characters (including trailing ellipses) given by the inherited DisplayWidth property.

The field provides the following additional properties:

CharacterSetName	The Firebird character set name of the string's character set.
CharacterSetSize	The maximum number of bytes in each character.
CodePage	The AnsiString code page associated with the Firebird Character Set.
DisplayTextAsClassName	If true then the inherited default behaviour is used for display text and the display text is no more than the classname. If false, then the display text is the contents of the field truncated, if necessary, as described above.

6.8.3.4 TIBArrayField

This is a specialised TField subclass used for Firebird array columns. It is described in section 9.2.

6.8.3.5 TIBDateTimeField

This is a subclass of TDateTimeField and holds additional information needed for time zone support. When the data type does not include a time zone then it behaves identically to TDateTimeField.

For a general discussion of the Firebird 4 TIMESTAMP/TIME WITH TIME ZONE data types, see appendix C of The Firebird Pascal API Guide [6].

The field provides the following additional properties:

HasTimeZone	True if the data type includes a time zone
TimeZoneName	The time zone name (e.g. CET or Europe/London) or the time zone offset is no time zone name was assigned (e.g. -08:00). Read/Write. If the time zone name is changed, the date time is left unchanged.
TimeZoneID	The Firebird (0..65535) time zone identifier (used by internal functions). Read/Write. If the time zone ID is changed, the date time is left

	unchange
TimeZoneFormat	Set to tfOffsetFromGMT or tfTimeZoneNameIfKnown (default). When the timestamp is formatted as a string and includes a time zone, setting the property to tfOffsetFromGMT forces the time zone name to always be rendered as a time zone offset. Otherwise, the value of the TimeZoneName property is used.

The field provides the following additional methods:

```
function GetAsDateTimeTZ(var aDateTime: TDateTime;
    var aTimeZoneID: TFBTimeZoneID): boolean; overload;
function GetAsDateTimeTZ(var aDateTime: TDateTime;
    var aTimeZone: string): boolean; overload;
function GetAsUTCDateTime: TDateTime;
procedure SetAsDateTimeTZ(aDateTime: TDateTime; aTimeZoneID: TFBTimeZoneID); overload;
procedure SetAsDateTimeTZ(aDateTime: TDateTime; aTimeZone: string); overload;
```

GetAsDateTimeTZ	Returns both the date time value and the time zone name (or ID). Note that TDateTimeField.AsDateTime may still be used. However, this only returns the date time component. If there is no time zone component then the time zone is always GMT.
GetAsUTCDateTime	The date time is convert to UTC (GMT in this context) before being returned as the function value.
SetAsDateTimeTZ	Sets the date time and time zone either by name or ID.

6.8.3.6 TIBTimeField

This is a subclass of TIBDateTimeField and exists only to ensure that when rendered as a string, there is no (empty) date included in the string.

6.9 Query Statistics

TIBDataSet, TIBQuery and TIBTable can all return query statistics.

6.9.1 Select Query Statistics

The following are supported by TIBDataSet, TIBQuery and TIBTable.

```
function GetPerfStatistics(var stats: TPerfCounters): boolean;
property EnableStatistics: boolean read FEnableStatistics write SetEnableStatistics;
```

If EnableStatistics is true when a dataset is opened then performance statistics will be accumulated for the select query used to read the dataset from the database. This is a published property and can be set at design time if required.

The function `GetPerfStatistics` can be called at any time after the dataset has been opened and will return the accumulated select query statistics. The statistics are initialised after the dataset is opened and then accumulate until the last record has been fetched from the dataset. The statistics counters returned are described in the Firebird Pascal API Guide [6] section 6.9.

The function returns false if statistics have not be requested or the dataset is not open.

6.9.2 Insert, Update and Delete Query Statistics

```
function GetRowsAffected(var SelectCount, InsertCount, UpdateCount, DeleteCount:
integer): boolean;
```

After changes to a dataset have been posted, or a row deleted, the `GetRowsAffected` function may be called to retrieve the affected rows counts. These counts are updated after each such action.

The function returns false if the dataset is closed.

6.9.3 GetRowsAffected for Select Queries

It is also possible to obtain the affected rows statistics for select queries if useful. IBX Datasets, also expose the select query statement handle as:

```
property SelectStmtHandle: IStatement {TIBDataset and TIBTable}
```

or

```
property StatementType: IStatement {TIBQuery}
```

In turn, this offers direct access to the `IStatement` `GetRowsAffected` method. For example:

```
var SelectCount, InsertCount, UpdateCount, DeleteCount: integer;
begin
  with TIBQuery.Create(Application) do
    try
      Active := true;
      Last; {fetchall}
      if StmtHandle.GetRowsAffected(SelectCount, InsertCount, UpdateCount, DeleteCount)
    then
      begin
        writeln('Selects = ', SelectCount);
        writeln('Inserts = ', InsertCount);
        writeln('Updates = ', UpdateCount);
        writeln('Deletes = ', DeleteCount);
      end;
    finally
      Free;
    end;
end;
```

6.10 User Permissions

IBX assumes that the logged on user has the appropriate permissions to perform the requested SQL queries.

- When using `TIBTable`, the user must have `Select`, `Insert`, `Update`, `References` and `Delete` privileges on the named database `Table`. If the user does not have sufficient privilege for any of the above, then an exception is raised when the dataset is opened.

- When using TIBDataSet, the user must have Select, Insert, Update, References and Delete privileges on the database objects identified in the respective, Select, Refresh, Insert, Modify and Delete queries. If the user does not have sufficient privilege for any of the above, then an exception is raised when the dataset is opened.

For a TIBDataSet, it is possible to work around this issue by not providing an Insert, Modify or Delete query, as appropriate. For example, if the user has only Select, Insert and Delete privileges then the dataset will open if the Modify query is empty. However, this means that any attempt to post an update to a row in the dataset will fail – but then the user was not allowed to do this in the first place,

- When using TIBQuery, the user must have the select privilege on the database objects contained in the SQL query. If the user does not have the Select Privilege, then an exception is raised when the dataset is opened.
- When using TIBUpdateSQL, the user must have the Select, Insert, Update, References and Delete privileges on the database objects identified in the respective, Refresh, Insert, Modify and Delete queries. If the user does not have sufficient privilege for any of the above, then an exception is raised when updates to the dataset are posted, or a row is deleted, respectively.

An important difference when using TIBQuery/TUpdateSQL, instead of TIBDataSet, is that in the former case, the dataset may be opened even when an Insert, Modify or Delete query is present in the TIBUpdateSQL and the user does not have sufficient privilege to perform one or more of these queries. It is only when the user attempts to perform an action not permitted by their assigned privileges does an exception result.

The use of TIBQuery/TUpdateSQL instead of TIBDataSet is thus preferred when developing an application for multiple users with different access rights.

- When using TIBStoredProc, the user must have the Execute privilege on the named procedure.

7

IBX Support Components

7.1 The IBX Script Engine

TIBXScript script engine runs an SQL script from a file or stream. The text is parsed into SQL statements which are executed in turn. The intention is to be compatible with Firebird's ISQL command line utility, but with extensions:

- All DML and DDL Statements are supported.
- CREATE DATABASE, DROP DATABASE, CONNECT and COMMIT are supported.
- The following SET statements are supported:
 - SET SQL DIALECT
 - SET TERM
 - SET AUTODDL
 - SET BAIL
 - SET ECHO
 - SET COUNT
 - SET STATS
 - SET NAMES <character set>
 - SET GENERATOR
- New Command: RECONNECT. Performs a commit followed by disconnecting and reconnecting to the database (calls TIBDatabase.Reconnect – see 5.1.7).
- Procedure Bodies (BEGIN .. END blocks) are self-delimiting and do not need an extra terminator. If a terminator is present, this is treated as an empty statement. The result is ISQL compatible, but does not require the use of SET TERM.
- DML statements may have arguments in IBX format (e.g UPDATE MYTABLE Set data = :mydata). Arguments are valid only for BLOB columns and are resolved using the

GetParamValue event. This returns the blobid to be used. A typical use of the event is to read binary data from a file, save it in a blob stream and return the blob id.

- The simple XML formats for binary blob data (see 7.6.4) and array data (see 7.6.5) as exported by TIBExtract (see 7.6) are supported.
- C++ style comment lines.

Select SQL statements are not directly supported but can be handled by:

1. An external handler (OnSelectSQL event).
2. A DataOutputFormatter. This formats the dataset returned by the select statement and writes the result to the Output Log.

If an SQL handler or a DataOutputFormatter is not present then an exception is raised if a Select SQL statement is found.

7.1.1 Properties:

Database	Link to a TIBDatabase component
Transaction	Link to a TIBTransaction. Defaults to internal transaction (concurrency, wait)
AutoDDL	When true, DDL statements are always committed after execution
Echo	When true, all SQL statements are echoed to log
StopOnFirstError	When true the script engine terminates on the first SQL Error.
IgnoreGrants	When true, grant statements are silently discarded. This can be useful when applying a script using the Embedded Server.
IgnoreCreateDatabase	When true, any CREATE DATABASE statements are silently discarded.
ShowAffectedRows	When true, the number of affected rows is written to the log after a DML statement is executed.
ShowPerformanceStats	When true, performance statistics (in ISQL format) are written to the log after a DML statement is executed.
DataOutputFormatter	Identifies a Data Output Formatter component used to format the results of executing a Select Statement.

7.1.2 Events:

GetParamValue	called when an SQL parameter is found (in PSQL :name format). This is only called for blob fields. Handler should return the BlobID to be used as the parameter value. If not present an exception is raised when a parameter is found. Hint: use TIBBlobStream to create and read the blob from a file.
OnOutputLog	Called to write SQL Statements to the log (stdout)
OnErrorLog	Called to write all other messages to the log (stderr)
OnProgressEvent	Progress bar support. If Reset is true the value is maximum value of progress bar. Otherwise called to step progress bar.
OnSelectSQL	handler for select SQL statements. If not present, then the DataOutputFormatter is used to process select SQL statements. If neither an OnSelect Handler or a DataOutputFormatter is defined then select statements. result in an exception. An OnSelectSQL handler may either process the select statement itself or call TIBXScript.DefaultSelectSQLHandler to invoke default processing as described above.
OnSetStatement	Handler for unrecognised SET Statements.
OnCreateDatabase	This event is called immediately prior to executing a Create Database SQL statement. For example, it gives an opportunity to review the filename given for the database and to replace it with an alternative.

7.1.3 Usage

The following TIBXScript functions may be used to execute an SQL statement or script:

```
function RunScript(SQLFile: string): boolean; overload;
function RunScript(SQLStream: TStream): boolean; overload;
function RunScript(SQLLines: TStrings): boolean; overload;
function ExecSQLScript(sql: string): boolean;
```

An SQL script may be passed as a File, a stream, a TStrings or as a single string. The above functions differ only in the way the script is provided. Otherwise, they are identical. The script is parsed into statements and executed one statement at a time in the order given in the script. The function returns true if all statements have been successfully executed and false otherwise.

7.1.4 Processing a Create Database Statement

If a CREATE DATABASE statement is read from the script and the IgnoreCreateDatabase property is false then the statement causes the current database to be dropped and a new

database created as specified by the CREATE DATABASE statement. Prior to it being executed, the statement is updated with the "filespec" (see [2]) taken from the original database connect string (DatabaseName property) and the user name and password from the TIBDatabase referenced from the TIBXScript.

The OnCreateDatabase is called prior to updating the statement and allows the "filespec" to be updated.

7.1.5 Examples

Two example programs are provided in the "ibx/examples" directory that illustrate the use of TIBXScript in both GUI and console mode. These are:

1. [ibx/examples/scriptengine](#)
2. [ibx/examples/fbsql](#)

7.1.5.1 The Script Engine Example

This example application illustrates use of the TIBXScript SQL script engine. It works with the example employee database and comes with various test scripts to illustrate how it works. These are all located in the "tests" directory.

Compile and run the application after first ensuring that the example employee database is available on the local server. If it is on a remote server, then you will have to adjust the IBDatabase1.DatabaseName property accordingly.

You can just type SQL queries into the left hand text box and click on "Execute" to run them. The results appear in the right hand text box. Select queries are supported by opening a new dynamically created window with a grid containing the query results. This window is non-modal and multiple query results can be shown simultaneously. The grid is a TIBDynamicGrid and clicking on the column header will resort the grid using the selected column.

The test scripts are loaded in the left hand text box by clicking on the "Load Script" button. The provided scripts are:

1. CreateCountriesTable.sql

This adds a new table "COUNTRIES" to the employee database and then populates it with country data including the country name and ISO2 and 3 character short names. At the end of the script, the contents of the new table are displayed.

2. CreateCountriesTablewithError.sql

This does the same as the above, except that the first insert statement contains a syntax error. It may be used to experiment with the "Stop on First Error" checkbox, and shows how the script engine can recover and continue from (some) syntax errors.

3. DeptListView.sql

This script adds a complex View to the database and tests the script engine in complex scenarios, such as recursive queries.

4. createproc.sql

This script adds three simple stored procedures. It demonstrates the different ways that procedure bodies can be declared (ISQL compatible, standard terminator and no terminator). Use of comments is also demonstrated.

5. ParameterisedQueries.sql

This script demonstrates the use of PSQL style query parameters for BLOB columns. In this case a new column "Image" is added to the COUNTRY Table and an image in png format (the flag of St George) is added to the entry for England. The value of the Image column is given by a parameter ":MyImage". This is resolved by the application which asks for the file containing the image to be placed in the field.

You should locate and return the "flag_en.png" file.

Note that the interactive resolution of the parameter is an example. The parameter resolution is carried out by an event handler that could, for example, have looked for a file which might conventionally have been called "MyImage.bin" to correspond to the query parameter.

6. Reverseall.sql

Reverses out the above.

7. SelectQuery.sql

Illustrates handling of select queries.

7.1.6 The fbsql Console Mode Application

fbsql is more than just a simple example and is an ISQL replacement console mode program for both interactive and non-interactive use. *fbsql* uses TIBXScript as its SQL Script Engine and TIBExtract (See 7.6) to extract metadata from the database. Select queries are handled by outputting the query results to *stdout* in CSV format suitable for loading into a spreadsheet, as insert statements, or in a block format. It also includes an interactive version of TIBXScript.

Usage: *fbsql* <options> <database name>

Options:

```
-a          write database metadata to stdout
-A          write database metadata and table data to stdout
-b          stop on first error
-e          echo sql statements to stdout
-i <filename> execute SQL script from file
-h          show this information
-o <filename> output to this file instead of stdout
-p <password> provide password on command line (insecure)
-r <rolename> open database with this rolename
-s <sql>    Execute SQL text
-t          specify output format for SQL Statements
            BLK (default) for block format
            CSV (default) for CSV format
            INS (default) for Insert Statement format
-u <username> open database with this username (defaults to SYSDBA)
```

Environment Variables:

ISC_USER Login user Name
ISC_PASSWORD Login password

Saving the username and/or password as environment variables avoids having to enter them on the command line and is a more secure means of providing the password.

If no password is provided on the command line or through the environment, then the user is prompted for a password to be entered securely.

If neither an "-s" or a "-i" option is provided on the command line, then `fbsql` runs interactively.

`fbsql` uses IBX in console mode. Before opening this project you should tell the Lazarus IDE about the `ibexpressconsolemode` package. All you need to do in the IDE is to select "Packages->Open Package File" and open `ibexpressconsolemode.lpk` which you can find in the `ibx` root directory. You should then close it again immediately afterwards. There is no need to install or compile it. Opening the package is sufficient for Lazarus to remember it.

SQL Statements Supported

- All DML and DDL Statements are supported.
- CREATE DATABASE, DROP DATABASE, CONNECT and COMMIT are supported.
- Additionally, RECONNECT is interpreted as dropping the connection and reconnecting.

ISQL Command Support

- SET SQL DIALECT
- SET TERM
- SET AUTODDL
- SET BAIL
- SET ECHO
- SET COUNT
- SET STATS
- SET NAMES <character set>
- SET HEADING
- SET ROWCOUNT
- SET PLAN
- SET PLAN ONLY
- QUIT
- EXIT

To use, compile the program in the Lazarus IDE and run it from the command line. See above for the command line parameters. For example:

```
fbsql -a -u SYSDBA -p masterkey employee
```

will write out the metadata for the local employee database to `stdout` (assuming default password).

```
fbsql -A -u SYSDBA -p masterkey -o employeedump.sql employee
```

will dump the employee database, include data, to a text file (`employeedump.sql`).

```
fbsql -u SYSDBA -p masterkey -i employeedump.sql
```

will recreate the database dumped in the file "employeedump.sql". Note that the "CREATE DATABASE" statement is at the start of this file and should be edited to identify the database file that is to be created. Alternatively,

```
fbsql -u SYSDBA -p masterkey -i employeedump.sql new-employee.fdb
```

will restore the database to the database file 'new-employee.fdb' provided that it has already been created as an empty database. Note that in this case, the "CREATE DATABASE" statement should remain commented out.

```
fbsql -s "Select * From EMPLOYEE" -u SYSDBA -p masterkey employee
```

will write out the contents of the EMPLOYEE table in the local employee database to stdout (assuming default password).

```
fbsql -b -e ../scriptengine/tests/CreateCountriesTable.sql -u SYSDBA -p masterkey employee
```

will run the script CreateCountriesTable.sql from the script engine test suite and apply it to the local employee database. Each statement will be echoed to stdout and processing will stop on the first error.

Note that on Linux, to run a program from the command line that is not on the PATH, you need to:

cd to the example directory "ibx/examples/fbsql"

run the program as "./fbsql" e.g.

```
./fbsql -a -u SYSDBA -p masterkey employee
```

7.2 The Data Output Formatters

These are helper components, primarily for use with TIBXScript, but which are also used by TIBExtract (for formatting data as SQL Insert statements). Their purpose is to execute SQL SELECT statements and to format the results of the query. Data Output Formatters are currently available for:

- Block Format Output (TIBBlockFormatOut)
- CSV Format (TIBCSVDataOut)
- SQL Insert Statements (TIBInsertStmtsOut).

7.2.1 Usage

For use with IBXScript: simply drop the appropriate component on to your form and link the TIBXScript DataOutputFormatter property to the required Data Output Formatter.

The Data Output Formatters may also be used directly. The properties listed below apply. All components support the following methods:

```
procedure Assign(Source: TPersistent); override;
procedure DataOut(SelectQuery: string; Add2Log: TAdd2Log);
procedure SetCommand(command, aValue, stmt: string; var Done: boolean); virtual;
class procedure ShowPerfStats(Statement: IStatement; Add2Log: TAdd2Log);
```

Assign: is used to copy the properties from one component to another.

DataOut: executes the supplied query. It formats the results as one or more lines and returns each line by calling the supplied "Add2Log" event handler.

SetCommand: is used by TIBXScript to extend the processing of SET commands to the Data Output Formatter. SET (HEADING | ROWCOUNT | PLAN | PLANONLY) commands are handled this way.

ShowPerfStats: is a common utility function used to format IStatement performance statistics in an ISQL compatible fashion.

7.2.2 Properties

Database	Link to a TIBDatabase component
Transaction	Link to a TIBTransaction. Defaults to internal transaction (concurrency, wait)
PlanOptions	Determines whether the execution plan is returned instead of, with, or not at all, when the query results are formatted.
RowCount	When non-zero, limits the number of output rows.
ShowPerformanceStats	When true, ISQL compatible Performance Statistics are included after the query results.
IncludeHeader	When true, a header row is included in the results (CSV and Block Formats only).
QuoteChar	Character used to delimit text in CSV format output (defaults to single quotes).
QuoteStrings	If false then strings are in CSV format are unquoted, otherwise, the QuoteChar property value is used to delimit each and every string in the output.
IncludeBlobsAndArrays	When true, insert statements include blob and array data formatted as XML (see 7.6.4 and 7.6.5)
FieldSeparator	The separator character(s) used to separate fields in data rows. Defaults to ','. (CSV format only)
HeaderSeparator	The separator character(s) used to separate fields in header rows. Defaults to ','. (CSV format only)
TimestampFormat	The date time format templates for the SQL type: TIMESTAMP. The format string uses the standard FPC date/time format characters. If set to an empty string, then the locale default is used. This uses the

	<p>ShortDateFormat and the LongTimeFormat. The locale default LongTimeFormat is extended by appending '.zzz' to include milliseconds.</p> <p>Note: the CSV Formatter by default sets this property to the empty string.</p>
DateFormat	<p>The date time format templates for the SQL type: DATE.</p> <p>The format string uses the standard FPC date/time format characters. If set to an empty string, then the locale default is used. This uses the ShortDateFormat.</p> <p>Note: the CSV Formatter by default sets this property to the empty string.</p>
TimeFormat	<p>The date time format templates for the SQL type: TIME.</p> <p>The format string uses the standard FPC date/time format characters. If set to an empty string, then the locale default is used. This uses the LongTimeFormat.</p> <p>Note: the CSV Formatter by default sets this property to the empty string.</p>

7.2.3 Events

OnFormatTextString	<p>This event handler can be used to process text strings before they are included in the output e.g. to replace unprintable characters with alternative strings.</p> <p>This only applies to columns with an SQL Type of SQL_VARYING and SQL_TEXT.</p>
--------------------	---

7.3 The SQL Parser

IBX 1.2 introduced the TSelectSQLParser class (located in the IBSQLParser unit). This class supports the parsing and modification of Firebird Select SQL statements. It is intended to parse all such statements including UNIONS and Common Table Expressions.

Note: its purpose is to permit reliable modification of “Where”, “Having” and “Order by” clauses in particular, and is not an SQL validator. While invalid SQL will often generate an exception, this is not guaranteed.

7.3.1 The Parser

The parser can be used as a standalone class, but is typically accessed using the “Parser” property of a TIBDataSet or a TIBQuery, and in a “BeforeOpen” event handler. Accessing the Parser property causes a TSelectSQLParser object to be created and its result is used when the dataset is opened.

An example of use may be found in `ibx/examples/employee` where it is used to filter the EMPLOYEE table query according to user selectable criteria. In this example, the BeforeOpen handler is

```
procedure TForm1.EmployeesBeforeOpen(DataSet: TDataSet);
begin
  if BeforeDate.Date > 0 then
    (DataSet as TIBParserDataSet).Parser.Add2WhereClause('HIRE_DATE < :BeforeDate');
  if AfterDate.Date > 0 then
    (DataSet as TIBParserDataSet).Parser.Add2WhereClause('HIRE_DATE > :AfterDate');

  case SalaryRange.ItemIndex of
  1:
    (DataSet as TIBParserDataSet).Parser.Add2WhereClause('Salary < 40000');
  2:
    (DataSet as TIBParserDataSet).Parser.Add2WhereClause('Salary >= 40000
                                                         and Salary < 100000');
  3:
    (DataSet as TIBParserDataSet).Parser.Add2WhereClause('Salary >= 100000');
  end;

  {Parameter value must be set after all SQL changes have been made}
  if BeforeDate.Date > 0 then
    (DataSet as TIBParserDataSet).ParamByName('BeforeDate').AsDateTime
                                     := BeforeDate.Date;
  if AfterDate.Date > 0 then
    (DataSet as TIBParserDataSet).ParamByName('AfterDate').AsDateTime := AfterDate.Date;
end;
```

In the example, two filters are available for user use:

- Restriction of “Hire Date” to a selected date range
- Restriction of salary to a drop down list of salary bands.

In each case, the filters need to be added to the SQL “Where” clause.

When the Parser object is first invoked, it is created using the original SQL text as set at design time. Calls to the method “Add2WhereClause” then do as expected – the supplied condition is ANDed with the existing “Where” Clause. An optional second parameter to Add2WhereClause is also available to OR the condition with the current “Where” clause (not shown).

In the above example, if the user has selected a given filter, then the SQL is updated as appropriate. Add2WhereClause can be called multiple times and each time it adds to the current text of the “Where” clause. Parentheses are automatically added in order to ensure that the semantics of the original condition are maintained.

In this example, the requested Hire Date could have been formatted as text e.g.

```
HIRE_DATE < '2015-01-01'
```

However, it is generally more reliable to let IBX handle date time conversions and so a parametrised query is used instead, with the parameter value being applied later on in the event handler.

Note that the example also illustrates an important rule: in a BeforeOpen event handler, parameter values must be set only after all SQL manipulation is complete. This is because the query must be “prepared” before parameter values are set and modifying the SQL always causes the query to be “unprepared” with the consequence that any parameter values are discarded.

In use, when a user changes a filter selection, the dataset is closed and re-opened causing the SQL to be re-generated and the result set appears with the filter applied.

A TIBDataSet SelectSQL or a TIBQuery SQL statement can still be updated at runtime. As before, this will close the dataset and unprepare the query. In addition, the initial SQL used for the Parser is also changed to the new value set at runtime.

7.3.2 Use with IBControls

The TSelectSQLParser is used by the IBControls (see chapter Error: Reference source not found). These controls also use the Parser property and access it before the BeforeOpen event handler is called.

7.3.3 Example

An example of direct use of the TSelectSQLParser can be found in `ibx/examples/sqlparser`. This is a simple form that can be used to experiment with the parser and see how the SQL statement is affected by calling methods such as `Add2WhereClause`.

As shown in Illustration 10, you can use the example program to test out the parser by:

- pasting an SQL Query into the “Original SQL” text box
- entering an SQL Condition into one or more of the text boxes below
- selecting the required options,
- and clicking on the “Generate Updated SQL” button.

The updated SQL Statement should now appear in the right hand text box.

The example chosen here is a fairly trivial one taken from the `ibx/examples/employee` program and shows a single filter clause being added to the SQL used to generate the employees list.

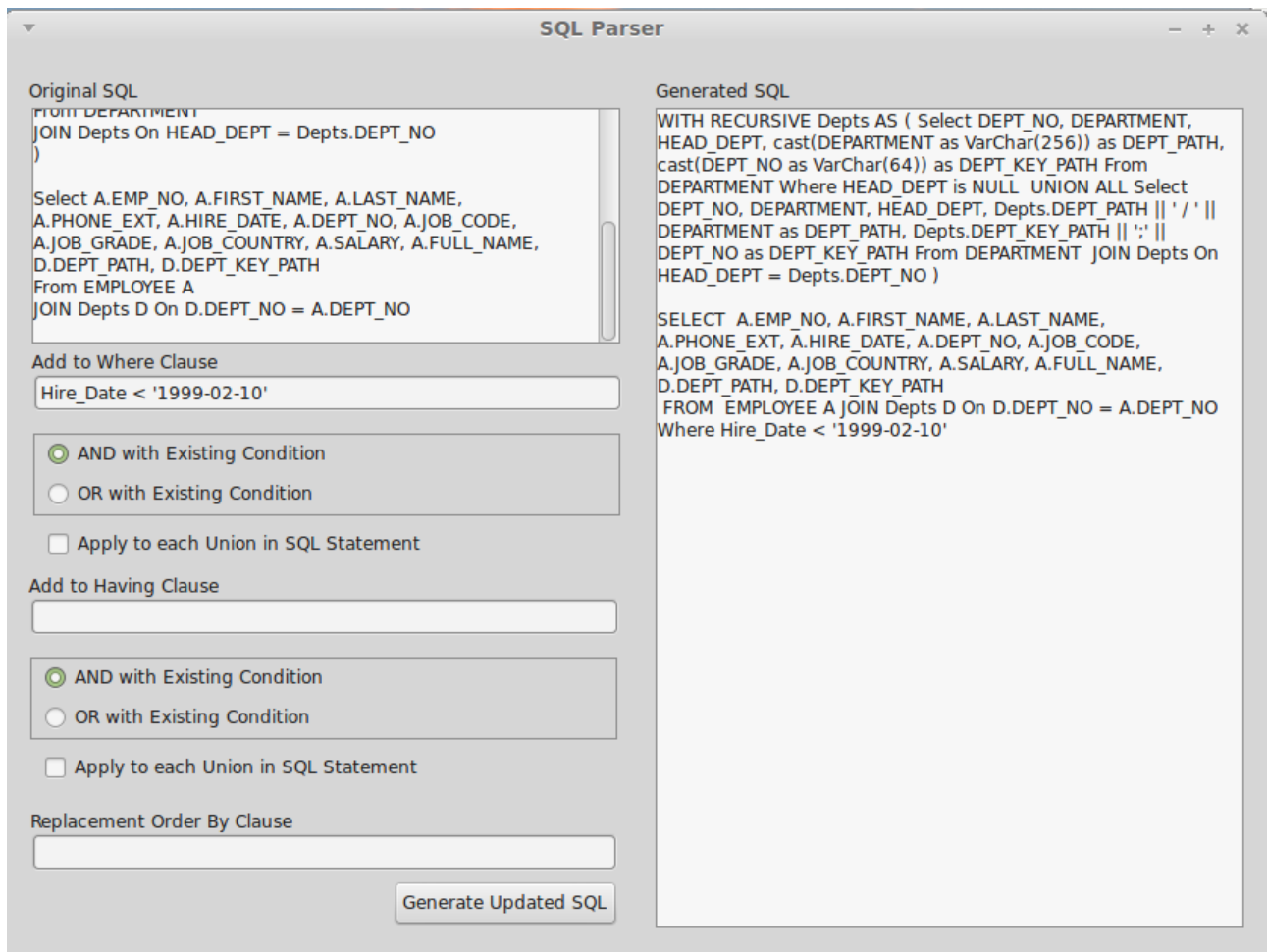

Illustration 10: SQL Parser Example

7.3.4 TSelectSQLParser Reference

For all properties and methods consult the source code. The following are those intended to be used in a BeforeOpen event handler:

- `procedure Add2WhereClause(const Condition: string; OrClause: boolean=false; IncludeUnions: boolean = false);`

This method is used to add an SQL condition to an SQL “Where” clause. If one does not exist in the original query, then the clause is added. By default, the condition is ANDed with the current “Where” condition. If the “OrClause” argument is true, then it is ORed.

By default, the condition is only added to the first select statement in a UNION. If the “IncludeUnions” argument is true, then it is added to every select statement in the UNION.

- `procedure Add2HavingClause(const Condition: string; OrClause: boolean=false; IncludeUnions: boolean = false);`

The behaviour of this method is identical to Add2WhereClause, except that it applies to the “Having” clause of the select statement.

- `property Union: TselectSQLParser;`

When the select statement is a union, the second select statement is accessible through the “Union” property. Each select statement in the union is recursively added to the preceding statement via this property.

- `property OrderByClause: string;`

The current “Order By” is accessed and replaced via this property. The text is the clause less the “Order by” keyword.

- `property SQLText: string`

This property returns the current SQL statement complete with any modifications. This property may be useful when debugging.

7.4 ISQL Monitor

The `TIBISQLMonitor` component is a debugging aid that lets you see all SQL operations performed by IBX. It can be used to identify bottlenecks and performance problems amongst other problems. An IBX application can monitor itself or, if permitted, it can also monitor another IBX application,

7.4.1 TIBISQLMonitor

This component needs only to be dropped on to a form and its `Enabled` property set to true in order to start monitoring. It does not have to be connected to any other IBX component. A `TIBISQLMonitor` component can act as a source or a sink, or both for SQL trace information.

7.4.1.1 Selecting what to monitor

The `TIBDatabase.TraceFlags` property determines the SQL actions to be reported to a `TIBSQLMonitor` object. The available actions are:

`tfQPrepare`, `tfQExecute`, `tfQFetch`, `tfError`, `tfStmt`, `tfConnect`, `tfTransact`, `tfBlob`, `tfService`, `tfMisc`

7.4.1.2 SQL Reports

The `TIBSQLMonitor.OnSQL` event handler is used to report each SQL action as a text message. Define a suitable event handler to receive text reports. These can be written to stdout, some log file or added to a `TMemo` for on screen reporting. The `TIBSQLMonitor.TraceFlags` determine which reported actions result in `OnSQL` handler calls.

7.4.1.3 Application Monitoring

Once a `TIBSQLMonitor` has been enabled, its output is available to other applications running on the same computer. Under Unix derivatives, this is limited to other applications running under the same user.

A monitoring application requires only a `TIBSQLMonitor` component. No other IBX component need be included in the application. Otherwise, the `TraceFlags` and `OnSQL` event handler are used identically to in application monitoring.

Note: if more than one source application is active, the monitoring application will report both sources and cannot readily filter one and not the other.

7.4.2 Examples

There are two simple example applications used here to show the power of TIBISQLMonitor. These are located in "ibx/examples/isqlmonitor"

7.4.2.1 Integrated Monitoring

This is a minor change to the Employee example and adds a second "Monitor Form" to record a selected set of SQL events in a TMemo journal. The events monitored can be changed by changing the trace options in the TIBDatabase.

7.4.2.2 Remote Monitoring

This example show how TIBISQLMonitor can be used to monitor another application. This application comprises one form containing a single TMemo used to record the SQL event journal. Run it at the same time as IntegratedMonitoring and you will see the SQL event journal here as well. Note that what is monitored is controlled from the IntegratedMonitoring application which sets the monitored events in its trace flags and must call "EnableMonitoring" for any monitoring to take place.

7.5 TIBDatabaseInfo

Firebird provides access to database properties and statistics and this access is supported in IBX through the TIBDatabaseInfo component.

To use this component simply drop it on to a form and link it to the database for which information is required. You can have more than one TIBDatabaseInfo component linked to the same database.

At run time, the component properties are used to get the current state of each property and statistic available. These are:

DBFileName	Database File Name
DBSiteName	Database site name
Allocation	Number of database pages allocated
BaseLevel	Database Version (level) number
DBImplementationNo	Database Implementation Number
NoReserve	Is space reserved for backup records
ODSMajorVersion	ODS minor version number
ODSMajorVersion	ODS version number
PageSize	Number of bytes per page
Version	Database implementation version no. (InterBase Format. See Firebird Version for the Firebird format version no.)
CurrentMemory	Amount of server memory (in bytes) currently in use

FirebirdVersion	This returns the current Firebird version string. Note that the Version property returns an InterBase compatible version string.
ForcedWrites	Number specifying the mode in which database writes are performed (0 for asynchronous, 1 for synchronous)
MaxMemory	Maximum amount of memory (in bytes) used at one time since the first process attached to the database
NumBuffers	Number of memory buffers currently allocated
SweepInterval	Number of transactions that are committed between "sweeps" to remove database record versions that are no longer needed
UserNames	List of Logged in users
Fetches	Number of reads from the memory buffer cache
Marks	Number of writes to the memory buffer cache
Reads	Number of page reads
Writes	Number of page writes
PagesFree	Number of free pages in the database.
PagesUsed	Number of used pages in the database.
BackoutCount	Number of removals of a version of a record by table. Formatted as a string list (see below).
DeleteCount	Number of database deletes since the database was last attached by table. Formatted as a string list (see below).
ExpungeCount	Number of removals of a record and all of its ancestors, for records whose deletions have been committed by table. Formatted as a string list (see below).
InsertCount	Number of inserts into the database since the database was last attached by table. Formatted as a string list (see below).
PurgeCount	Number of removals of old versions of fully mature records (records that are committed, so that older ancestor versions are no longer needed) by table. Formatted as a string list (see below).
ReadIdxCount	Number of reads done via an index since the database was last attached by table. Formatted as a string list (see below).
ReadSeqCount	Number of sequential table scans (row reads) done on each table since the database was last attached by table. Formatted as a string list (see below).
UpdateCount	Number of database updates since the database was last

	attached by table. Formatted as a string list (see below).
DBSQLDialect	Database SQL Dialect
ReadOnly	True if database is read only
DateDBCreated	Date/Time when the database was originally created
TransactionCount	Number of active transactions.
Encrypted	True if database is encrypted (Firebird 3.0.3 and later)
EncryptionKeyName	Name of the encryption key if available (Firebird 3.0.3 and later)

From IBX 2.2, TIBDatabaseInfo also supports the following function:

```
function GetDatabasePage(PageNo: integer): string;
```

This returns the contents of database “PageNo” as a string with a codepage of CP_NONE. This feature is allowed only for SYSDBA or database owner for security reasons. Introduced in Firebird v2.5.

7.5.1 Per Table Counts

Several of the above properties return database information as a string list giving the count per table. Each line is in the format:

<Relation ID>=<count>

The <Relation ID> is an integer and may be resolved to a table name using the RDB\$RELATIONS table. For example, the SQL query:

```
SELECT trim(r.RDB$RELATION_NAME) as RDB$RELATION_NAME
FROM RDB$RELATIONS r Where r.RDB$RELATION_ID = ?
```

may be used to look up the table name from the RDB\$RELATIONS table.

7.6 TIBExtract

This component allows the extract of database metadata. The component is intended to be compliant with all Firebird extensions to the DDL up to and including Firebird 3.

The “ibx/examples/fbsql” example provides an example of the use of this component in a console mode application.

To use: at design time simply drop the component on to a form and, in the Object Inspector, link it to the required TIBDatabase.

7.6.1 Properties

AlwaysQuoteIdentifiers	If true then in database dialect 3 SQL identifiers are always delimited by double quotes. If false, then they are only delimited if the identifier is a reserved word, contains lower case or special
------------------------	---

	characters.
CaseSensitiveObjectNames	<p>If false (default) then ObjectNames (see ExtractObject method below) are converted to upper case before matching against metadata object names, unless the objectname is delimited by double quotes, in which case, the double quotes are removed and the remaining string is used (unmodified) to match against the metadata object name.</p> <p>If true then the ObjectName is used as is without modification and matched against the metadata object name. No attempt is made to remove double quotes.</p>
IncludeMetaDataComments	If true (default) then metadata comments are included in DDL.
ShowSystem	Used when extracting comments or using the ListObjectNames method. If true then comments include those on system objects and the object names include system objects.

7.6.2 Usage

At run time, the ExtractObject method may be used at any time when the database is connected, and in order to extract selected metadata.

```
procedure ExtractObject(ObjectType : TExtractObjectTypes; ObjectName : String = '';
                      ExtractTypes : TExtractTypes = [])
```

After the method has completed, the TIBExtract.Items string list property will hold the extracted metadata.

The extract object types determine the scope of the metadata extracted, while the Extract Type set further refines what is generated:

Extract Object	Extract Type	Metadata
eoDatabase		The whole database schema including grants to all objects except users other than user PUBLIC.
	etGrantsToUser	Include grants to all users.
	etData	The whole database schema plus the data as DML Insert statements immediately after the table definitions. This include binary Blobs (see 7.6.4) and Array data (see 7.6.5) in text format.
eoDomain	etDomain	All Domains
	etTable	Domains used in the specified table

Extract Object	Extract Type	Metadata
eoTable		Specified table or all tables if no table given
	etDomain	Adds domains defined for the table
	etIndex	Adds indexes defined for the table
	etForeign	Adds Foreign Key Constraints defined for the table
	etCheck	Adds Check Constraints defined for the table
	etTrigger	Adds Table Triggers defined for the table
	etGrant	Adds Table Grants defined for the table
	etData	Adds table data as DML INSERT statements.
eoView		List all views or just the one given by the ObjectName
	etTrigger	Adds Triggers defined for the view
	etGrant	Additionally includes grants on the View and to any triggers.
eoProcedure		List all Procedures or just the one given by the ObjectName
	etGrant	Additionally includes grants to and on the procedure.
eoPackage		List all Package definitions (header and body) or just the one given by the ObjectName (Firebird 3 or later only)
	etGrant	Additionally includes grants to and on the package.
eoFunction		List all Functions or just the one given by the ObjectName
eoGenerator		List all Generators or just the one given by the ObjectName
	etData	Additionally includes an "ALTER SEQUENCE" statement to set the generator to the current value
eoException		List all Exceptions or just the one given by the ObjectName

Extract Object	Extract Type	Metadata
eoBLOBFilter		List all Blob Filters or just the one given by the ObjectName
eoRole		List all Roles or just the one given by the ObjectName
	etGrant	Additionally includes grants to the Role
eoTrigger		List all Triggers or just the one given by the ObjectName
	etTable	List all Triggers for the ObjectName (table name)
	etDatabaseTriggers	List all Database Triggers or just the one given by the ObjectName
	etDDLTriggers	List all DDL Triggers or just the one given by the ObjectName
	etGrant	Additionally includes grants to the Trigger
eoForeign		List all Foreign Keys or just the one given by the ObjectName
	etTable	List all Foreign Keys for the ObjectName (table name)
eoIndexes		List all indexes or just the one given by the ObjectName
	etTable	List all indexes for the ObjectName (table name)
eoChecks		List all Check Constraints or just the one given by the ObjectName
	etTable	List all Check Constraints for the ObjectName (table name)
eoComments		List all metadata comments.
eoData		Lists table data as DML INSERT statements for the specified table.

When an entire database is extracted, the order of objects is:

- Commented out CREATE DATABASE statement
- Filters

- External Functions
- Domains (except for Check constraints)
- Tables
- Data (if requested)
- Indexes
- Foreign Key constraints
- Generators including setting the value if requested
- Views
- Domain Check Constraints
- Check Constraints
- Exceptions
- Create Procedure Stubs
- Create Function stubs
- Triggers
- Alter Procedure statements to add procedure body
- Alter Function statements to add function body
- Metadata Comments on Character Sets and Collations (if any)
- Grants

This order is important to avoid dependency problems. The data is added as soon as the tables have been defined. This avoids problems with Foreign Key and check constraints without having to add the data in dependency order.

Procedure stubs are created before triggers to enable triggers to use procedures. However, the procedures cannot be fully defined until the triggers have been defined. Otherwise, an error will occur if a stored procedure is used to update a writeable views; views are only writeable once triggers have been defined.

7.6.3 Listing Database Objects

The method:

```
procedure ListObjectNames(ObjectType: integer; Names: TStrings);
```

may be used to list, in the TStrings “Names”, the names of all objects of the requested type in the database. ObjectType can be either: obj_relation, obj_view, obj_trigger, obj_procedure, obj_function, obj_exception, obj_index, obj_character_set, obj_sql_role, obj_generator, obj_blob_filter, obj_collation, obj_package, obj_domain.

7.6.4 Extract of Binary Blobs

TIBExtract exports binary blobs in a simple XML format and as hexadecimal characters. For example:

```
<blob subtype="0">
89504E470D0A1A0A0000000D4948445200000122000000AE0803000000A565F09300000015504C54
45FFFFFFCE1124CC0005EDB8BBEEBCBFC0016E1858B135C5E220000018949444154789CEDDAB10D
C3301004415AA4D47FC97607133E04EF5470D8F8D69AB5AF0F5C7B78E2B4125189A84454222A1195
884A4425A2125189A84454222A1195884A4425A2125189A84454222A1195884A4425A2125189A844
54222A1195884A4425A2125189A84454222A1195884A4425A2125189A84454222A1195884A4425A2
125189A84454222A1195884A4425A2125189A84454222A1195884A4425A2125189A844749CE84C6F
DCA3CE732BD1FD9CD98DEB9AC542BF46C3139727FE8B125189A84454222A1195884A4425A2125189
A84454222A1195884A4425A2125189A84454222A1195884A4425A2125189A84454222A1195884A44
5DB0A8231F4D5F2DDF70071DD6A9984A4425A2125189A84454222A1195884A4425A2125189A84454
222A1195884A4425A2125189A84454222A1195884A4425A2125189A84454222A1195884A4425A212
5189A84454222A1195884A4425A2125189A84454222A1195884A4425A2125189A84454222A119588
4A4425A2125189A84454222A1195884A4425A21724FA0255D0459DFD53A3DD000000049454E44AE
```

```
426082
</blob>
```

In the above example, a binary blob of subtype '0' is formatted as lines of hexadecimal characters. It is terminated by the </blob> end tag. White space is intended to be ignored when the blob data is read back in. There are always an even number of hexadecimal characters on each line.

The above can be placed in a DML statement instead of a placeholder for a blob value. For example:

```
INSERT INTO MyTable (KeyValue,BlobData) Values(1,<blob subtype="0">
89504E470D0A1A0A0000000D4948445200000122000000AE0803000000A565F09300000015504C54
...
</blob>);
```

7.6.5 Extract of Array Data

TIBExtract exports array data in a similar simple XML format. For example:

```
<array dim = "1" sqltype = "448" length = "60" relation_name = "JOB" column_name =
"LANGUAGE_REQ" charset = "NONE" bounds="1:5">
  <elt ix="1">Japanese
</elt>
  <elt ix="2">Mandarin
</elt>
  <elt ix="3">English
</elt>
  <elt ix="4">
</elt>
  <elt ix="5">
</elt>
</array>
```

The above is more complex than a blob and reflects the structural information that is necessary to define an array. The above example comes from the example employee database and is the value of a LANGUAGE_REQ column in the JOB table.

The “array” tag identifies:

- dim: the number of dimensions in the array
- sqltype: the SQL type of the array data (using blr type codes)
- length: the size of each array element in bytes.
- relation_name: the name of the table in which the array is defined.
- column_name: the name of the column in that table.
- charset: the name of the character set (text data only)
- bounds: a comma separated list of lower and upper bound pairs, one pair for each dimension. Each pair is separated by a ':' character.

The array element values are then nested within “elt” tags. The first level element tag is for the first dimension, and provides its index, and then so on. The inner set of “elt” tags encloses the value of the array element.

For example, in a 2D array:

```
<array dim="2" ... bounds="1:5,1:2">
  <elt ix="5">
    <elt ix="2">English</elt>
  <elt>
</array>
```

In the above, a single element is defined with co-ordinated (5,2).

7.7 TIBJournal

TIBJournal is a non-visible component supporting the use of Client Side Database Journaling. Database Journal is described in the *Firebird Pascal API Guide* [6] section 14. This component controls the use of Client Side Database Journaling for a given database.

7.7.1 Properties

Database	Link to a TIBDatabase component
Enabled	Set to True to start journaling and to false to stop journaling
JournalFileTemplate	JournalFileTemplate determines the name of the journal file and should include a %d where %d is replaced with the session no at run time
Vendor Name	Vendor Name and ApplicationName determine the location of the Journal file. The Journal file is saved in: Unix: \$HOME/.<vendor name>/<application name>/ Windows: <User Application Data Dir>\<vendor name>\<application name>\
Application Name	
RetainJournal	If RetainJournal is true then when journaling terminates (Enabled := false), or a normal database close, the journal file and journal table (IBX\$JOURNALS) entries are retained. Otherwise, they are discarded. Note: the journal file is always retained on a Forced Disconnect or a lost connection. Default false.

7.7.2 Events

OnJournalEntry	This event is called each time a log entry is written to the journal file. It may be used to process the journal entry by alternative means. If this event handler is present then no entries are written to the log file.
----------------	--

7.7.3 Usage

TIBJournal is normally added to a project at design time. If Enabled is set to true at Design Time then a journal is always created when the database is opened. Depending on the setting of the RetainJournal property it may be deleted when the database is closed normally.

When journaling is used to support debugging database access logic, then RetainJournal is normally set to true and the developer can then use the journal to debug logic errors.

If journaling is used to support recovery when a database connection is lost then then it should be noted that the journal file is always left in place when a database connection is lost even if RetainJournal is false. It may then be played back to restore the database to the intended state.

7.7.4 Playback

The TIBJournal.ReplayJournal method may be used to restore a database to the intended state following a lost connection.

This method loads and analyses a journal file, identifying any incomplete read/write transactions and any insert/update/delete queries that had been executed under each such transaction. The playback algorithm will then start each such transaction and execute the queries in temporal order. Once finished, each transaction is finalised using the default completion setting for the transaction.

7.7.4.1 Generators

Firebird Generators (Sequences) exist outside of any transaction and once incremented the new value is visible to all active transactions. A lost database connection has no impact on the database's generators.

If generators are used in the preferred manner for an IBX Dataset i.e. defined and used via the GeneratorField property then playback should give the expected result. This is because the insert/update query contains the literal value returned when the generator is incremented. This should be consistent with any references from other tables to this value.

However, a problem may result if an insert/update query sets a field value to a value returned by the GEN_ID function that is part of the query SQL. This is always a new value and is different from any returned the first time the query was executed. Any references to the original value in the journal will thus be invalid.

Note: playback is intended for use on the same database for which the connection was lost. Any other database with the same schema (e.g. an empty database) will have different generator values which are likely to be inconsistent with the journal file.

7.7.5 Playback in a Client Program

IBX allows for transactions to be given unique names. These names are recorded in the journal file. It is thus possible for a user to write their own playback function using the application's own TIBTransaction objects (located by name). The advantage of this approach is that, assuming the transactions are left open when playback is complete, the application's IBX Datasets may now be opened and appear to have the same state as when the connection was lost. The application user can now continue to complete their work.

8

Using Firebird Blobs

Binary Large Objects (Blobs) are containers for almost unlimited amounts of binary data held within a Firebird Database. In practice, Blobs are limited by the database architectural limits and available disk storage but, perhaps the most important point is that their individual size limit is not part of the metadata. IBX supports the use of Firebird Blobs.

8.1 Blob Types

From the IBX viewpoint, there are two types of Firebird Blob:

- Text mode Blobs (sub type 1) that consist of character data in known character set (e.g. UTF8), or
- Binary mode Blobs for which the data type is unknown to IBX.

Note: Firebird allows for many different Blob types in addition to text blobs without giving any semantics to them. IBX does not impose any additional semantics on non-text Blob types.

8.1.1 Text Mode Blobs

Text Mode Blobs are represented by a `TIBMemoField` dataset field type. This is a `TBlobField` descendent and provides access to the Blob Data as `AnsiStrings`:

- Use the `AsString` property to both read and write the entire text blob. On reading, the `AnsiString` code page corresponds to the character set used to transfer the Blob. On writing, transliteration may occur if the `AnsiString` code page of the string is different to that which corresponds to the character set used to transfer the Blob.
- Use the `SaveToFile` method to save the contents of a text blob to a file.
- Use the `LoadFromFile` method to load the contents of a text blob from a file.

The data aware control TMemo, can be used to both display and edit the text in a text blob.

In practice, the main difference between TIBMemoFields and basic string fields is that the former has no strong limits on how long the string is, and which is limited only by architectural constraints.

8.1.2 Binary Blobs

Binary blobs are used for many different purposes including holding image data. Binary Blobs are represented by the TBlobField dataset field type:

- Use the AsString property to both read and write the entire text blob. The string is always read as an untyped string and, on write, any string code page is ignored.
- Use the SaveToFile method to save the contents of a binary blob to a file.
- Use the LoadFromFile method to load the contents of a binary blob from a file.

If the Blob contains image data, then the TDBImage control may be used to display and update the Blob data.

8.2 Stream Mode access to Blobs

IBX also allows Blob Fields to be read and updated using the TStream class. IBX datasets give access to a Blob stream using the CreateBlobStream method inherited from TDataset. i.e.

```
function CreateBlobStream(Field: TField; Mode: TBlobStreamMode): TStream;
```

The function requires a TBlobField or a TIBMemoField to identify the blob field. The mode indicates whether the stream is for reading (bmRead) or writing (bmWrite). Read/Write access is also possible. The dataset must be in Edit mode if the Blob is to be written to.

A Blob stream may be read from or written to in the same way as any other TStream descendent.

A Blob updated using a Blob stream updates the data in the current row. This must be “posted” in order to be written to the database.

For example:

```
var S, F: TStream;
begin
  MyDataset.Edit;
  S := MyDataset.CreateBlobStream(MyBlobField, bmWrite);
  F := TFileStream.Create('someimage.png', fmOpenRead);
  S.CopyFrom(F, 0);
  MyDataset.Post;
  S.Free;
  F.Free;
```

9

Using Firebird Arrays

Firebird allows you to create arrays of data types. Using an array enables multiple data items to be stored in a single column. Firebird can perform operations on an entire array, effectively treating it as a single element, or it can operate on an array slice, a subset of array elements. An array slice can consist of a single element, or a set of many contiguous elements.

Starting with IBX2, IBX now offers full support for Firebird Arrays:

- The Firebird Language Bindings in the *fbintf* package provide both *IArray* and *IArrayMetaData* interfaces. The former is used to access and manage an array or array slice, while the latter can be queried to find out information about the array such as its type, number of dimensions, etc.
- IBX itself now includes *TIBArrayField*. This is a *TField* descendent and, like any other *TField* descendent (e.g. *TStringField*) provides the means to access an array element when it is returned by a *TDataSet* descendent as a field of the current row. *TIBArrayField* provides the *IArray* interface as one of its properties enabling direct access to the array.
- The *IBControls* Package now includes a *TIBArrayGrid* visual control (see Error: Reference source not found). This is a *TCustomStringGrid* descendent and may be used to display and edit an array element. Examples are provided for both one and two dimensional arrays.

The *IArray* interface is documented as part of the *fbintf* package.. See the Firebird Pascal API Guide chapter 8.

9.1 Defining an Array Element

This is fully described in the Firebird Document. For example:

```
Alter Table MyData (
  ...
  MyArray VarChar(16) [0:16, -1:7] Character Set UTF8
```

```
);
```

An array may have a different set of values for each row. In the above example, a two dimensional array of strings is defined. The first index may vary from 0 to 16 and the second from -1 to 7.

9.2 TIBArrayField

TIBArrayField is used and behaves much the same as any other TField Descendent. It can be created in the IDE using the Fields Editor and saved as part of a form (and then accessed as a property of the form) or dynamically, when a TIBCustomDataSet descendent (e.g. TIBTable, TIBQuery, etc.) is opened (it can then be accessed (e.g.) using the "FieldByName" method).

TIBArrayField defines the following additional properties:

ArrayID: TISC_QUAD	This provides access to the Firebird internal array identifier stored in the row itself. This is not normally of direct interest to users.
ArrayIntf: IArray	This provides access to the array interface used to access and update the array element. When the field is null, this returns an empty array and setting an element of this array to any non-empty value will make the field non-null after the record has been posted. Assigning an empty array to this property provides an alternative means to setting the field to null. (Setting the field IsNull property to true is the recommended method).
ArrayDimensions: integer	Returns the number of dimensions in the array.
ArrayBounds: TArrayBounds	This is a (pascal) dynamic array and returns an element for each dimension in the array, providing the upper and lower bound for that dimension.

TIBArrayField also provides an additional method:

```
function CreateArray: IArray;
```

This may be used to obtain an interface to a new empty array and which is compatible with the field. Once populated, it can be assigned to the ArrayIntf property and its contents will be saved as the value of the array field once the dataset has been "posted".

Note: it is possible to retain a copy of the ArrayIntf and access it after the dataset has been scrolled. However, an exception is raised if an attempt is made to alter the contents of an array that is not linked to the current row of its TDataSet.

10

Using Firebird Services

The Firebird Services API was introduced in InterBase 6.0 and is available in all versions of Firebird. It supports:

- Access to server and per database properties and statistics
- Database Backup and Restore
- Security Database Management (user credentials)
- Database Validation and Error Recovery
- Database configuration parameter management.

These functions correspond to the functionality provided by the Firebird command line utilities `gbak`, `gfix` and `gsec`.

IBX provides access to the services API through a set of non-visual components located on the Firebird Admin palette. Each component is focused on a specific subset of the Services API. An example program illustrates the use of each of the Firebird Admin components. This is located in `ibx/examples/services`.

The IBX Services components were re-architected in IBX 2.3 with the intent of providing a clearer and easier to use set of components. This chapter describes the new set of components introduced with IBX 2.3. For documentation of the legacy IBX Services components see Appendix A.

10.1 Introducing the new IBX Services Components







At first sight, the new set of components looks very similar to the previous set with the component names differing only by being prefixed by `"TIBX"`, instead of `"TIB"`. However, there are also some important differences:









- There is a new `TIBXServicesConnection` component. This represents the connection to the Firebird Services API and provides a single focus for managing the connection. In the legacy components, each component was designed to have a separate Services API

connection. The programmer then had to copy connection parameters between components to avoid the user having to log in separately to each service. The new component subclasses TCustomConnection and is hence similar to TIBDatabase.

- The services components have lost the “ServerName” and “Params” properties and any others associated with the services connection. These are replaced with a reference to the common TIBXServicesConnection component.
- The “ServiceStart” and similar level methods are no longer publicly visible. Instead, methods are available that carry out the intended function in a single call. In many cases, a single “Execute” method is used.
- Separate Client and Server side backup and restore components are available with properties and methods appropriate to each type
- There are two TMemDataset subclasses available (TIBXServicesUserList and TIBXServicesLimboTransactionsList). These are available as managed datasets for User Management and Limbo Transaction Resolution and which can be used as Data Sources for a TDBGrid.

10.2 Firebird Admin Component Overview

	TIBXServicesConnection	This represents the connection to the Firebird Services API and provides a single focus for managing the connection. It is required for all applications that use the Services API. It is a TCustomConnection descendent.
	TIBXClientSideBackupService	The client side backup service supports database backup to gbak format archives and with the destination on the client system.
	TIBXServerSideBackupService	The server side backup service supports database backup to gbak format archives and with the destination on the server.
	TIBXClientSideRestoreService	The client side restore service supports database restore from a gbak format archive located on the client system.
	TIBXServerSideRestoreService	The server side restore service supports database restore from a gbak format archive located on the server.
	TIBXConfigService	The configuration service allows database parameters to be modified, including whether the database is online, sync versus async writes, etc.
	TIBXServerProperties	This service retrieves various server properties including the server version information, server parameters and the current status of database

		attachments.
	TIBXLogService	This service supports the retrieval of the server log file contents.
	TIBXStatisticalService	This service supports the retrieval of per database statistics.
	TIBXSecurityService	This service supports management of the User Security Database.
	TIBXValidationService	This service supports the invocation of various database repair actions, including validation and sweep.
	TIBXLimboTransactionResolution Service	This services allows both the listing of any Limbo Transactions and their resolution.
	TIBXOnlineValidationService	This service was introduced for Firebird 3 and provides for a table level validation of a database. It implements consistency checks that do not require exclusive access to a database.
	TIBXServicesUserList	This is a TMemDataset descendent and works with a TIBXSecurityService to provide a means to display and manage the users on a given server.
	TIBXServicesLimboTransactions List	This is a TMemDataset descendent and works with a TIBXLimboTransactionResolutionService to provide a means to display and fix a database's Limbo transactions, if any.

10.3 Common Concepts

A TIBXServicesConnection represents the connection to a given Server's Services API and at least one TIBXServicesConnection component must be included in a project in order to use the Services API.

The functions available through the Services API are then packaged into individual components, each of which provides a related set of services.

- All components that provide access to the Services API have a "ServicesConnection" property that identifies the TIBXServicesConnection component providing the connection to the Server's Services API.

- Each component that accesses services targeted on a named database, have a “DatabaseName” property. This is either an alias name or the full pathname of a database on the server to which the TIBXServicesConnection is connected to.

10.3.1 Common Reporting and Event Handling

Many of the services components return a report in an OutputLog (TStrings). This is typically returned by the Execute Method i.e.

```
procedure Execute(OutputLog: TStrings);
```

Each line in the report is returned individually from the server. However, the OutputLog is only available when the action completes. However, it is possible to inspect each line of text as it is returned using the service’s OnGetNextLine event handler:

```
TIBXOnGetNextLine = procedure(Sender: TObject; var Line: string) of object;
property OnGetNextLine: TIBXOnGetNextLine read FOnGetNextLine write FOnGetNextLine;
```

This can be used to give a line by line output, or simply to make the presentation of the log more responsive. For example, when setting the OutputLog to a TMemo.Lines, the TMemo can be made to update after each line is appended by creating an OnGetNextLine event handler containing:

```
Application.ProcessMessages;
```

If the event handler is used to display each line and there is no role for an OutputLog, then the parameter may be set to nil.

10.4 The TIBXServicesConnection

All applications using the IBX Services Components must have at least one TIBXServicesConnection component. This represents the connection to a server’s Services API and is used by all the IBX Services components. It is a subclass of TCustomConnection and follows the same model as similar descendants such as TIBDatabase.

10.4.1 Properties

Connected	Set to true to attach to the server and establish a connection with it. Set to false to terminate an active connection.
ConfigOverrides	This is a list of configuration settings in the same syntax as the “firebird.conf” file. It may be used to provide client side settings that override the defaults in the local “firebird.conf” file.
ConnectionString	This contains the connect string used to establish a connection with the server. It may either be set directly or via the separate ServerName, Protocol and PortNo. Properties.
FirebirdLibraryPathName	This published property is normally left empty. If not empty then it should be set to the pathname for the Firebird Library (DLL or so). If empty, IBX searches well known locations for the library. The property is typically used when the library file is not in an expected location or to force the selection of a specific file when several

	<p>versions are available. The same guidelines apply to the use of this property as for its use with a TIBDatabase (see 5.1.12).</p> <p>Note: the pathname is platform dependent.</p>
FirebirdAPI	This read only public property returns the IFirebirdAPI interface to the Firebird Library used to access the services interface.
LoginPrompt	Set to true to enable use of the built-in login prompt dialog.
Params	Holds the login user name and password, as a list of keyword equals string (e.g. user_name=SYSDBA, password=masterkey). It is recommended that the password is not set at design time. A component editor is available to set each service's parameters.
Protocol	<p>Determines the connection type (local, TCP, SPX, Named Pipe, inet, wnet or xnet). See the Firebird documentation for more information.</p> <p>Updating this property automatically updates the ConnectString.</p>
ServerName	The (domain) name of the server. Updating this property automatically updates the ConnectString.
PortNo	The port number on which the server is listening. Only required for a non-default server port number. Updating this property automatically updates the ConnectString
ServerVersionNo	A read only integer array [1..4] giving the Firebird Release number (elements 1..3) and the build no. (element 4).
ServiceIntf	<p>The public property ServiceIntf exposes the IServiceManager interface used to communicate with the server. This interface is available (non-nil) when Connected is true.</p> <p>From IBX 2.3.3 onwards, this property is read/write. This, for example, allows the same services connection to be shared between multiple instances of TIBXServicesConnection.</p>
WireCompression	<p>This is a “convenience” property. If set to true then “WireCompression=true” is added to the ConfigOverrides property, If set to false then then “WireCompression=” line is removed from ConfigOverrides.</p> <p>Note: you may set “WireCompression=false” explicitly in the ConfigOverrides in order to override a default of “WireCompression=true”.</p>

10.4.2 Event handling

In addition to the standard TCustomConnection events, TIBXServicesConnection also supports:

OnLogin	<p>This can be used to replace the built-in login dialog to provide the servername, username and password either programatically or by your own dialog or some other means of determining the user name and password.</p> <p>This event is only called if LoginPrompt is true.</p>
OnSecurityContextException	<p>This event is called when handling an exception due to a user database using a different security database to that to which the service is currently logged into. It is used to direct the services connection as to how it is to be resolved. The event handler should return:</p> <ul style="list-style-type: none"> • scRaiseError (default) to abort the current action and raise an exception. • scReconnect to drop the current services API connection and to log in using the same security database as used by the user database. This will typically result in the user being prompted to enter a new username and password valid for the security database (either using the built-in login dialog or by invoking the OnLogin event handler if set).

10.4.3 Connecting to the Services Manager

The simplest way to connect to the Services Manager is to set the “Connected” property to true. The TIBXServicesConnection will then attempt to connect to the Services Manager using the Connect String, the parameters given in the component properties, and any ConfigOverrides given.

Alternatively, the “ConnectUsing” method may be used:

```
procedure ConnectUsing(aDatabase: TIBDatabase);
```

This creates a compatible Services API connection for the aDatabase database connection. The database connection must be in its connected state. The Services API connection is then established such that:

- The Server Name, Protocol and Port No are extracted from the database connect string.
- The ConfigOverrides are copied from the database ConfigOverrides.
- A Local connection (using the embedded server) is used if and only if the database connection is also using the embedded server.
- If the database connection was authenticated using an alternative security database then an “expected_db” parameter is added to the login parameters so that the services connection is also logged in using the same security database.

- All components using the `TIBXServicesConnection` and which have a `DatabaseName` property (e.g. `TConfigService`) will have their `DatabaseName` property set to the database name extracted from the `TIBDatabase` connect string.

The `ConnectUsing` procedure does not change the “Params” property. That is the user name, password and sql role name specified in the `Params` property will be those used for connecting to the Services API. If the `LoginPrompt` is true then a Login Dialog will still appear, or the `OnLogin` event will be called.

If it is desired to use the same `Params` settings as used for the database, then the `SetDBParams` method may be used to copy them prior to calling `ConnectUsing`.

```
procedure SetDBParams(DBParams: TStrings);
```

10.5 The Backup Service

The backup service supports database backup to `gbak` format archives. Both server side and client side backup file locations are supported by providing two specialised versions of the Backup Service. Before the backup is started, the following common properties and events may be set:

<code>ServicesConnection</code>	Required: a reference to the <code>TIBXServicesConnection</code> providing the connection to the server. This must be in its connected state in order to perform a backup.
<code>BackupFiles</code>	Server Side Backups only: This is a list full pathnames to one or more backup files on the server. When more than one is specified, all but the last should be followed by “=nnn” where nnn is the maximum length in bytes for the file.
<code>BlockingFactor</code>	See <code>gbak</code> documentation for non-zero values (probably obsolescent)
<code>DatabaseName</code>	Alias of or full pathname for database on the server. Note: this is not a connect string and does not include the servername, portno or protocol components.
<code>Options</code>	See <code>gbak</code> documentation for interpretation of each option.
<code>Verbose</code>	Server Side Backups only: if true then additional text messages are generated.
<code>StatisticsRequested</code>	In verbose mode additional statistics may be provided with in the output log: <ul style="list-style-type: none"> • Total Time • Time Delta • Page Reads • PageWrites
<code>OnGetNextLine</code>	Server side backups only: This event is called whenever a line of text is

	received from the server.
--	---------------------------

10.5.1 Server Side Backup

The following method is called to perform a server side backup:

```
procedure Execute(OutputLog: TStrings);
```

The backup is made from the database to the backup file(s). If OutputLog is non-nil then any lines of text received from the server during the backup (usually in verbose mode only) are added to the TStrings passed as the parameter. The method returns on completion.

10.5.2 Client Side Backup

The following methods are available for a client side backup:

```
procedure BackupToStream(S: TStream; var BytesWritten: integer);
procedure BackupToFile(aFileName: string; var BytesWritten: integer);
```

These are used to backup the database given by the DatabaseName to either a TStream or a named file. On completion, the number of bytes received and written to the file are returned.

10.6 The Restore Service

The Restore service supports database restore from gbak format archives. Both server side and client side backup file locations are supported. Before the restore is started, the common properties must be set plus the following:

ServicesConnection	Required: a reference to the TIBXServicesConnection providing the connection to the server. This must be in its connected state in order to perform a database restore.
DatabaseFiles	A list of one or more full pathnames for the database file(s) on the server.
Options	See gbak documentation for interpretation of each option. This must include either CreateNewDB (default) or Replace, but not both.
PageBuffers	See gbak documentation
PageSize	See gbak documentation
Verbose	If true then additional text messages are generated.
StatisticsRequested	In verbose mode additional statistics are provided with the output log: <ul style="list-style-type: none"> • Total Time • Time Delta • Page Reads

	<ul style="list-style-type: none"> • PageWrites
OnGetNextLine	Server side restores only: This event is called whenever a line of text is received from the server.

10.6.1 Server Side Restores

The method used to perform a server side restore is performed after the above properties have been set:

```
procedure Execute(OutputLog: TStrings);
```

The Database is restored to the specified file(s) using the archive(s) given in the BackupFiles list. If OutputLog is non-nil then any lines of text received from the server during the backup (usually in verbose mode only) are added to the TStrings passed as the parameter. The method returns on completion.

10.6.2 Client Side Restores

The following methods are available for a client side restore i:

```
procedure RestoreFromStream(S: TStream; OutputLog: TStrings);
procedure RestoreFromFile(aFileName: string; OutputLog: TStrings);
procedure RestoreFromFiles(FileList: TStrings; OutputLog: TStrings);
```

These methods may be used, respectively, to restore the database from an archive sourced from a TStream, a named file, or a list of named files. If OutputLog is non-nil then any lines of text received from the server during the backup (usually in verbose mode only) are added to the TStrings passed as the parameter.

10.7 The Configuration Services

The TIBXConfigService comprises a set of methods, each of which performs a specific action. The following properties must be set:

ServicesConnection	Required: a reference to the TIBXServicesConnection providing the connection to the server. This must be in its connected state to use any of the configuration services.
DatabaseName	Alias of or full pathname for database on the server. Note: this is not a connect string and does not include the servername, portno or protocol components.

The following methods are available, each of which sets the associated attribute for the database identified by DatabaseName,

ShutdownDatabase	Puts the database into its shutdown state according to the selected options and within the given "wait" time (seconds). Once shutdown,
------------------	--

	only the SYSDBA user can log into the database.
BringDatabaseOnline	Puts the database into its online state (reverse of shutdown).
SetSweepInterval	Sets the automatic sweep interval
SetDBSqlDialect	Sets the default database SQL dialect (1 or 3)
SetPageBuffers	Set the default number of cache buffers to the specified number.
ActivateShadow	Activates a database "shadow file" See the Firebird Documentation for more information on database shadow files.
SetReserveSpace	Configure the database to fill data pages when inserting new records (true), or reserve 20% of each page for later record deltas (true)
SetAsyncMode	Toggles between async writes (true) and sync writes (false).
SetReadOnly	Sets read only or read/write mode.
SetNoLinger	Set the No Linger Flag on a database. This is a "one-shot" override. Once set, the server will close the database immediately the last attachment is gone, regardless of the LINGER setting in the database. The LINGER setting is retained and works normally the next time.

10.8 The Server Properties Service

This service retrieves various server properties including the server version information, server parameters and the current status of database attachments. The following property is required in order to use the service:

ServicesConnection	Required: a reference to the TIBXServicesConnection providing the connection to the server. This must be in its connected state in order to access server properties.
--------------------	---

The information returned is divided up into:

- Server Version Information
- Active Database Information, and
- Configuration Parameters

This information is made available as public properties which may then be read to access the requested information. Accessing a property automatically retrieves the requested information set from the database, which is then cached until the connection is terminated. These properties are:

VersionInfo	<pre>ServerVersion: String; ServerImplementation: string;</pre>
-------------	---

	ServiceVersion: Integer;
DatabaseInfo	NoOfAttachments: Integer; NoOfDatabases: Integer; DbName: array of string; {List of connected databases}
ConfigParams	ConfigFileData: TConfigFileData; ConfigFileParams: array of string; BaseLocation: string; LockFileLocation: string; MessageFileLocation: string; SecurityDatabaseLocation: string;

For example:

```
var i: integer;
begin
  with IBServerProperties1 do
  begin
    writeln('Server Version = ' + VersionInfo.ServerVersion);
    writeln('Server Implementation = ' + VersionInfo.ServerImplementation);
    writeln('Service Version = ' + IntToStr(VersionInfo.ServiceVersion));

    writeln('No. of attachments = ' + IntToStr(DatabaseInfo.NoOfAttachments));
    writeln('No. of databases = ' + IntToStr(DatabaseInfo.NoOfDatabases));
    for i := 0 to DatabaseInfo.NoOfDatabases - 1 do
      writeln('DB Name = ' + DatabaseInfo.DbName[i]);

    writeln('Base Location = ' + ConfigParams.BaseLocation);
    writeln('Lock File Location = ' + ConfigParams.LockFileLocation);
    writeln('Security Database Location = ' + ConfigParams.SecurityDatabaseLocation);
  end;
end;
```

10.9 The Log Service

This is a simple service that may be used to retrieve the current server log file contents. The following property is required in order to use the service:

ServicesConnection	Required: a reference to the TIBXServicesConnection providing the connection to the server. This must be in its connected state in order to access the server log.
--------------------	--

The server log is retrieved using the Execute method:

```
procedure Execute(OutputLog: TStrings);
```

When the method returns, the current server log will have been added to the OutputLog.

10.10 The Database Statistics Services

This service supports the retrieval of per database statistics as text data. The following properties must be set:

ServicesConnection	Required: a reference to the TIBXServicesConnection providing the connection to the server. This must be in its connected state in order to retrieve database statistics.
DatabaseName	Alias of or full pathname for database on the server. Note: this is not a connect string and does not include the servername, portno or protocol components.
Options	Used to request the category of the statistics returned.

The options available are:

HeaderPages	Request only the information in the database header page
DataPages	Request statistics for user data pages
IndexPages	Request statistics for user index pages
SystemRelations	Request statistics for system tables and indexes — in addition to user tables and indexes

The statistics requested are retrieved using the Execute method:

```
procedure Execute(OutputLog: TStrings);
```

When the method returns, the requested statistics will have been added to the OutputLog.

10.11 The Security Service

The TIBXSecurityService service supports management of the User Security Database. It supports:

- The listing of all User Names, and other user identification information
- Adding New Users
- Modifying Existing Users (including changing passwords)
- Deleting Users.
- From Firebird 2.5 onwards, display and management of the user Admin Role.
- From Firebird 2.5 onwards, setting the global "Auto Admin" state.

The following property is required in order to use the service:

ServicesConnection	Required: a reference to the TIBXServicesConnection providing the connection to the server. This must be in its connected state in order to access the security services.
--------------------	---

10.11.1 Listing all User Names

The `DisplayUsers` method is used to retrieve the list of user names and other user identification information to the `UserInfo` property. This information can then be displayed to the user. For example:

```
var i: integer;
begin
  with IBSecurityService1 do
  begin
    DisplayUsers;
    for i := 0 to UserInfoCount - 1 do
    with UserInfo[i] do
    begin
      writeln('User ID = ',UserID);
      writeln('Group ID = ',GroupID);
      writeln('User Name = ',UserName);
      writeln('First Name = ', FirstName);
      writeln('Middle Name = ', MiddleName);
      writeln('Last Name = ', LastName);
      write('Admin Role = ');
      if AdminRole then writeln('true') else writeln('false');
    end;
  end;
end;
```

10.11.2 Adding a User

The `AddUser` method is used to add a user to the Security Database. The `TIBSecurityService` `UserName` and `Password` properties should be set before this method is called to set the user name and password, respectively. The complete set of properties that may be set are:

UserName	User (or Login) Name
Password	The user's password
FirstName	The user's first name
MiddleName	The user's middle name
LastName	The user's last name
UserID	The Unix UID
GroupID	The Unix GID
AdminRole	True if the user is granted the Admin Role, otherwise false.

The following illustrates the use of the `AddUsers` method:

```
with IBSecurityService1 do
begin
  UserName := NewUserName;
  Password := NewPassword;
```

```
AddUser;
end;
```

10.11.3 Updating User Details

The `ModifyUser` method is used to modify a users login details in the Security Database. The `UserName` property acts as the key identifying the user. The remaining properties listed above in 10.11.2 may be set as required to update the corresponding entry in the database. For example:

```
with IBSecurityService1 do
begin
  UserName := 'SYSDBA';
  FirstName := 'Donald';
  LastName := 'Duck';
  ModifyUser;
end;
```

10.11.4 Deleting a User

The `DeleteUser` method is used to remove a users login details from the Security Database. The `UserName` property acts as the key identifying the user. For example:

```
with IBSecurityService1 do
begin
  UserName := 'ALICE';
  DeleteUser;
end;
```

10.11.5 Setting the Auto Admin State

In Firebird 2.5, automatic SYSDBA mapping was given more control when operating under “Trusted Authentication” and with a new DDL instruction:

```
ALTER ROLE RDB$ADMIN SET/DROP AUTO ADMIN MAPPING
```

that may be used to configure this function on and off on a per server basis. This mapping can also be set through the services API and in IBX is performed using the Security Service's `SetAutoAdmin` method.

```
procedure SetAutoAdmin(Value: Boolean); {true = set auto admin mapping}
```

10.12 The User List DataSet

The `TIBXServicesUserList` is a subclass of a `TMemDataset` (from the FCP-db package). It is provided in order to provide a simple means of User Management through a dataset. The `TIBXServicesUserList` may be used as a data source for (e.g) a `TDBGrid` allowing all User Management to be performed by editing the rows in a grid.

It has the following required properties:

Source	Reference to a <code>TIBXSecurityService</code> component that will be used as the user list source and to update the user credentials.
FieldDefs	A predefined set of Field definitions each corresponding to a user attribute in the server's security database. Do not remove or rename

	any FieldDef. However, the initial list may be added to if necessary.
--	---

The predefined FieldDefs are:

UserID	Integer	Legacy Unix User ID
GroupID	Integer	Legacy Unix Group ID
SEC\$USER_NAME	String(31)	User Name
SEC\$FIRST_NAME	String(32)	First Name (info only)
SEC\$MIDDLE_NAME	String(32)	Middle Name (info only)
SEC\$LAST_NAME	String(32)	Last Name (info only)
SEC\$PASSWORD	String(32)	<p>Password.</p> <p>Normally set to null. If a row is edited and the Password field is set to a non-null value then the user password is updated when row is posted.</p> <p>Note: This field is not normally displayed in a TDBGrid and is intended to be updated by (e.g.) some change password dialog.</p>
SEC\$ADMIN	Boolean	If true then user has RDB\$ADMIN role in security database.

In use:

- Setting the dataset's Active property to true retrieves the user list from the server and populates the dataset (sorted by username) with the user attributes.
- Editing a dataset row permits user attributes to be changed. When the dataset's "Post" method is called, the changes are sent to the server.
- Adding a row is equivalent to adding a new user.
- Deleting a row is equivalent to deleting a user.

10.13 The Validation Service

The TIBXValidationService supports the invocation of various database repair actions, including validation and sweep. Exclusive access is required to the database in order to perform these validation activities.

Note: Limbo transaction resolution is provided by a separate service: TIBXLimboTransactionResolutionService (See 10.15).

The following properties must be set:

ServicesConnection	Required: a reference to the TIBXServicesConnection providing the connection to the server. This must be in its connected state in order to perform database repair activities.
DatabaseName	Alias of or full pathname for database on the server. Note: this is not a connect string and does not include the servername, portno or protocol components.
Options	Used to request the repair activity and options.

The following Database Repair services are available and selected by the service's options property:

Title	Option	Description
Kill Shadow Files	KillShadows	Remove references to unavailable shadow files
Mend Database	MendDB	Mark corrupted records as unavailable, so subsequent operations skip them
Sweep Database	SweepDB	Request database sweep to mark outdated records as free space;
Validate Database	ValidateDB	Locate and release pages that are allocated but unassigned to any data structures
Full Database Validation	ValidateFull	Check record and page structures, releasing unassigned record fragments. Use with Validate Database
Check Database	CheckDB	Request read-only validation of the database, without correcting any problem
Ignore all checksum errors	IgnoreChecksum	Refines database check

In practice, the first four options are mutually exclusive, while the last three are options for "ValidateDB" while ValidateFull and IgnoreChecksum are options for "MendDB".

Once the repair action and options have been selected, the repair action is performed by the Execute method:

```
procedure Execute(OutputLog: TStrings);
```

When the method returns, the results, if any, reported for the repair action will have been added to the OutputLog.

10.14 The Online Validation Service

Online Validation was introduced in Firebird 2.5 that allows some consistency checks to be performed without exclusive access to the database. It may:

- validate some (or all) user tables in a database.
- validate some (or all) indices

Other ODS checks, such as Header/PIP/TIP/Generators pages, are not performed by Online Validation. The TIBXOnlineValidationService component is the IBX interface to online validation.

10.14.1 Properties

ServicesConnection	Required: a reference to the TIBXServicesConnection providing the connection to the server. This must be in its connected state in order to perform database repair activities.
DatabaseName	Alias of or full pathname for database on the server. Note: this is not a connect string and does not include the servername, portno or protocol components.
IncludeIndexes	This is a regular expression selecting the indexes to include in online validation. Leave empty to include all indexes.
ExcludeIndexes	This is a regular expression selecting the indexes to exclude from online validation. Leave empty to exclude none.
IncludeTables	This is a regular expression selecting the tables to include in online validation. Leave empty to include all tables.
ExcludeTables	This is a regular expression selecting the tables to exclude from online validation. Leave empty to exclude none.
LockTimeout	This is the lock timeout in seconds. default is 10 secs. 0 is no-wait, -1 is infinite wait.

The validation action is performed by the Execute method:

```
procedure Execute(OutputLog: TStrings);
```

When the method returns, the results, if any, reported for the online validation action will have been added to the OutputLog.

10.15 The Limbo Transaction Resolution Service

The `TIBXLimboTransactionResolutionService` may be used to list and fix any transactions remaining in limbo as a result of a failed two phase commit action across two or more databases. The following properties must be set:

ServicesConnection	Required: a reference to the <code>TIBXServicesConnection</code> providing the connection to the server. This must be in its connected state in order to retrieve database statistics.
DatabaseName	Alias of or full pathname for database on the server. Note: this is not a connect string and does not include the servername, portno or protocol components.

10.15.1 Listing the In Limbo Transactions

There are two steps to the resolution of limbo transactions. The first step retrieves a list of all limbo transactions. The second step commits or rolls back each transaction as required.

The list of In Limbo Transactions is made available through two properties:

LimboTransactionInfoCount	This returns the number of In Limbo Transactions for the identified database.
LimboTransactionInfo	This is an array property and for each index returns the <code>TLimboTransactionInfo</code> for an In Limbo Transaction. The array is zero based and has <code>LimboTransactionInfoCount</code> members.

Accessing either of the above properties will cause the current list of In Limbo Transactions to be returned from the server and then cached locally.

For example:

```
var i: integer;
begin
  with IBXLimboTransactionResolutionService1 do
  begin
    for i := 0 to LimboTransactionInfoCount - 1 do
    with LimboTransactionInfo[i] do
    begin
      write('ID = ',ID);
      if MultiDatabase then
        write(', Multi DB')
      else
        write(', Single DB');
      write(', Host Site = ', HostSite);
      write(', Remote Site = ', RemoteSite);
      write(', Database Path = ', RemoteDatabasePath);
      write(', State = ', StateToStr(State));
      writeln(', Advise = ', AdviseToStr(Advise));
    end;
  end;
end;
```



```
end;
```

where

```
function StateToStr(State: TTransactionState): string;
begin
  case State of
    LimboState:
      Result := 'Limbo';
    CommitState:
      Result := 'Commit';
    RollbackState:
      Result := 'Rollback';
    else
      Result := 'Unknown';
  end;
end;

function AdviseToStr(Advise: TTransactionAdvise): string;
begin
  case Advise of
    CommitAdvise:
      Result := 'Commit';
    RollbackAdvise:
      Result := 'Rollback';
    else
      Result := 'Unknown';
  end;
end;
```

This list identifies each limbo transaction and its current state, it also suggests an action (advise). The user can review the list and set the `TLimboTransactionInfo.Action` property to a desired outcome.

10.15.2 Fixing the In Limbo Transactions

The limbo transactions may then be resolved by setting the `GlobalAction` property and then calling the `Execute` method.

```
procedure Execute(OutputLog: TStrings);
```

The `GlobalAction` determines how `FixLimboTransactionErrors` processes the limbo transactions and may be set to:

<code>CommitGlobal</code>	All limbo transactions are resolved by committing the transaction.
<code>RollbackGlobal</code>	All limbo transactions are resolved by rolling back the transaction.
<code>RecoverTwoPhaseGlobal</code>	All limbo transactions are resolved by performing a two phase commit of the transaction.
<code>NoGlobalAction</code>	Limbo transactions are resolved by either committing or rolling back the transaction, as specified by each limbo transaction's <code>Action</code> property.

Each In Limbo transaction is processed in turn and the cached list of In Limbo Transaction is then emptied. Any text lines returned by the server is added to the OutputLog on return.

10.16 The Limbo Transaction List Dataset

The TIBXServicesLimboTransactionsList is a subclass of a TMemDataset (from the FCP-db package). It is provided in order to provide a simple means of In Limbo Transaction Resolution through a dataset. The TIBXServicesLimboTransactionsList may be used as a data source for (e.g) a TDBGrid allowing all In Limbo Transaction Resolution to be performed by editing the rows in a grid.

It has the following required properties:

Source	Reference to a TIBXServicesLimboTransactionsList component that will be used as the user list source and to update the user credentials.
FieldDefs	A predefined set of Field definitions each corresponding to a In Limbo Transaction attribute. Do not remove or rename any FieldDef. However, the initial list may be added to if necessary.

The predefined FieldDefs are:

TransactionID	Integer	Limbo Transaction ID
TransactionType	String(16)	'Multi DB' or 'Single DB'
HostSite	String(256)	Server Domain Name
RemoteSite	String(256)	Client Domain Name
DatabasePath	String(256)	Database Name on Server
State	String(32)	'Limbo'; 'Commit'; 'Rollback'; or 'Unknown';
RecommendedAction	String(32)	'Commit'; 'Rollback'; or 'Unknown';
RequestedAction	String(32)	'Commit' or 'Rollback'

In use:

- Setting the dataset's Active property to true retrieves the In Limbo Transaction list from the server and populates the dataset with the Limbo Transaction attributes.
- Only the RequestedAction should be editable and constrained to one of the above values.
- Row Deletion is not permitted (ignored).
- Row Append is not permitted (exception raised).

Once the In Limbo Transaction Resolution options have been selected, the current list can be resolved by calling the `TIBXServicesLimboTransactionsList` method:

```
procedure FixErrors(GlobalAction: TTransactionGlobalAction; OutputLog: TStrings);
```

This method calls the `TIBXLimboTransactionResolutionService.Execute` method after setting the requested `GlobalAction`. On successful completion, any information returned by the server is added to the `OutputLog` and the dataset is refreshed.

11

Personal Databases

A Personal Database is one held on the same system on the client and, where possible, file system access rights ensure that only the owner has access to the data. Instead of database access using a remote server running as a separate process, the server is embedded in the client and is both inherits and is constrained by the user's access rights.

In Firebird 2.5 and earlier, the embedded server is deployed as a separate package, while in Firebird 3 the same code libraries can be as part of a standalone server or as an embedded server.

The embedded server will be used if available and the database pathname is to a local file without a preceding server name. Access to the database will fail if the user has insufficient access rights.

The *fbintf* package provides direct and largely transparent support for use of the embedded server. See section 4.10 of the Firebird Pascal API Guide for more information. Deployment Guidelines are available in chapter 13 of the same guide.

IBX additionally recognises the case where a local database path has been specified but a database open error prohibits use of the embedded server. It will automatically prefix the database path with "localhost:" and try again hoping to use the local server, if available.

IBX also provides additional support for Personal Databases that are accessible via the embedded server.

11.1 TIBLocalDBSupport

TIBLocalDBSupport is non-visual component supporting a TIBDatabase and intended to simplify the use of the embedded firebird server for Personal Database Applications, on both Linux and Windows platforms. The TIBLocalDBSupport component supports GUI programs, while the TIBCMLocalDBSupport provides the same support for console mode programs. [Example applications](#) are provided for both GUI and console mode in the `ibx/examples/local-employee.db` directory.

When enabled, TIBLocalDBSupport provides:

- Verification that the embedded Firebird Server is in use.
- Setup of the FIREBIRD environment variable for the embedded server.
- DatabaseName, and login parameters management.
- Use of the Firebird Services API to initialise an empty local database from a gbak format Firebird archive.
- Use of the Firebird Services API to save the current local database to a gbak format Firebird archive.
- Use of the Firebird Services API to replace the contents of the current local database from a gbak format Firebird archive.
- Use of the TIBXScript Engine for automated field upgrade of the local database.

To use the component, simply drop it onto a form or data module and link it to the TIBDatabase.

11.1.1 Properties

Database	reference to the TIBDatabase component for the local database
DatabaseName	filename (no path) to use for the Firebird Database file.
EmptyDBArchive	filename (optional path) holding the database initialisation archive. May either be absolute path or relative to shared data directory .
Enabled	when false component does nothing
FirebirdDirectory	Full path to directory holding firebird.conf. May either be absolute path or relative to the shared data directory . If empty, defaults to shared data directory.
InOnCreateDB	This is set to true while a new local database is being created and its schema populated. Useful in (e.g.) TIBDatabase.OnAfterConnect handler to suppress actions when the database is disconnected/connected during the create DB procedure.
Name	Component Name
Options	<ul style="list-style-type: none"> • <code>ibAutoUpgrade</code>: Automatically apply upgrade when database schema version is lower than required. • <code>IblAllowDowngrade</code>: Automatically apply downgrade when available to schema version compatible with the required

	<p>version.</p> <ul style="list-style-type: none"> • <code>iblQuiet: true</code> then no database overwrite warnings
<code>RequiredVersionNo</code>	The schema version number required by the application. <code>TIBLocalDBSupport</code> will normally try to upgrade/downgrade the schema to satisfy this requirement.
<code>UpgradeConfFile</code>	Path to upgrade configuration file. May either be absolute path or relative to the shared data directory .
<code>SectionHeaderTemplate</code>	This defaults to 'Version.%.3d' and is used to generate the section header names (for a given version no.) in the upgrade.conf file.
<code>VendorName</code>	Used to construct path to Database Directory.

Note that at design time paths may use '/' or '\' as directory separator. At run time, they must be specified using the appropriate Directory Separator for the current platform.

11.1.2 Events:

<code>OnGetDatabaseName</code>	The database path name is normally computed automatically. However, this event allows an application to inspect and override the result.
<code>OnNewDatabaseOpen</code>	called after the successful initialisation of an empty local database.
<code>OnGetDBVersionNo</code>	called to get the current database schema version number. If this event is not handled then schema upgrade/downgrade is never performed.
<code>OnGetSharedDataDir</code>	The shared data directory is normally computed automatically. However, this event allows an application to inspect and override the result.

11.1.3 Shared Data Directory

The shared data directory is the base directory for all static data files used by `TIBLocalDBSupport`. This is determined as follows:

- Windows: the application executable's location.
- Unix: the application executable's location unless this is `/usr/bin`, `/usr/local/bin`, `/usr/sbin` or `/usr/local/sbin`, when the shared data directory is set to `/usr/share/<application name>` or `/usr/local/share/<application name>` depending on whether the application is in `/usr` or `/usr/local`.

Note: that the <application name> is taken from `sysutils.ApplicationName` and defaults to the filename of the application executable less any extension.

11.1.4 DatabaseName, and login parameters management

When `TIBLocalDBSupport` is in use, the `TIBDatabase.DatabaseName` property is ignored and instead, it is generated algorithmically as:

- Windows: "User Application Directory"\VendorName\DatabaseName
- Unix: "User Home Directory"/."VendorName"/DatabaseName

The "DatabaseName" comes from the `TIBLocalDBSupport.DatabaseName` property.

The "VendorName" comes from the `TIBLocalDBSupport.VendorName` property. If the `TIBLocalDBSupport.VendorName` property is left empty then `Sysutils.VendorName` is used. If this is empty then no VendorName component is present in the path.

Note the use of a hidden directory under Unix.

If the generated DatabaseName is not appropriate then the `TIBLocalDB.OnGetDatabaseName` event handler gives a chance to inspect it and change it to something different.

The Database Params are copied from the `TIBDatabase` component except that the "user_name" and "password" parameters are removed if present. When running under Windows, the "user_name" is then set to "SYSDBA" and the "password" to "masterkey". Under Unix, these parameters are omitted.

11.1.5 Database Initialisation

When the linked `TIBDatabase` connected property is set to "true", `TIBLocalDBSupport` generates the DatabaseName (as described above) and then if it does not correspond to an existing file, `TIBLocalDBSupport` uses the Firebird Services API to create the database file from an "empty database" archive in gbak format, or an SQL Script. In practice, the archive can contain both the database metadata and initial table data. An SQL Script may also contain data inline compatible with `TIBXScript` (see 7.1)

The "empty database" archive is given by the `TIBLocalDBSupport.EmptyDBArchive` property. This should be a filename (with the .gbk extension or .sql extension) and may include an optional path. Relative paths are interpreted as relative to the [shared data directory](#).

For a gbak archive, the Services API (see 10.6) is then used to create the initial database from this archive. The `IBXScript` component is used to create a database from an SQL Script. An error is raised if the archive is not present.

The SQL script may or may not include a CREATE DATABASE SQL statement. If it does then the file name is replaced with the required filename for the database. If no such statement is present then one is generated using the required filename for the database and the character set specified in the database parameters as the connection character set.

The local database can be re-initialised at any time by calling the `TIBLocalDBSupport.NewDatabase` method.

11.1.6 Saving the Current Database

The current database contents can be saved at any time by a call to `TIBLocalDBSupport.SaveDatabase`. The filename for the archive can be provided in the method call. If empty, then the user is prompted to enter a filename (default extension `.gbk`).

The Services API (see 10.5) is then called to archive the database to the specified file in `gbak` format.

11.1.7 Restoring the Database from an Archive

The local database can be overwritten (restored) from any archive in `gbak` format (including those saved using the `SaveDatabase` method) by calling the `TIBLocalDBSupport.RestoreDatabase` method. The filename for the source archive can be provide in the method call. If empty, then the user is prompted to locate the file.

The Services API (see 10.6) is then called to restore the local database from the archive.

11.1.8 Database Schema Upgrade

A Software Application Update can also require a corresponding update to the database schema. With embedded Firebird server applications where the user may not even be aware that a database server is in use, it is important to have a means to field upgrade the database schema in as seamless and automatic a manner as possible. `TIBLocalDBSupport` supports a suitable mechanism using the `TIBXScript` engine (see 7.1).

The underlying idea is that the database schema comes with a version number given as a single integer. The first version to be released is version 1, the second is version 2 and so on. The current schema version number must be saved as data somewhere in the database. As this is database schema dependent, `TIBLocalDBSupport` does not know how to determine the current database schema number and instead relies upon the application responding to the [OnGetDBVersionNo](#) event.

Each version of an application will have a maximum and minimum version of the database schema that it can support, and it is expected to check that the schema version is acceptable in its `TIBDatabase` `OnConnect` handler. However, before this handler is called, `TIBLocalDBSupport` will itself check the current schema version against its `RequiredVersionNo` property (which should be set to the maximum supported schema version no).

- If `ibAutoUpgrade` is given in the `Options` property and the current schema is less than the `Required Version no.`, then `TIBLocalDBSupport` will attempt to apply the upgrade rules to raise the version number to that required.
- If `ibAllowDowngrade` is given in the `Options` property and the current schema is greater than the `Required Version no.`, then `TIBLocalDBSupport` will attempt to locate a suitable backup archive and restore this as the current database. This case is usually only found in the unlikely event of a failed upgrade and the user has installed an older version of the software in order to recover from the problem.

The schema upgrade rules are read from the [upgrade configuration file](#). This is a text file in "ini" file format with the following sections:

[status]

This should have a single named value “current” giving the current database schema number as in integer e.g.

current = 2

This should normally be set to the same value as the RequiredVersionNo property and acts as a check to ensure that both are in sync.

[Version.nnn]

Where nnn is an integer with leading zeroes. For example, “Version.002” is the section read to upgrade the database schema from version 1 to version 2. This section can contain the following named values:

Name	Type	Use
Upgrade	string	Name and optional path to the SQL script used to perform the upgrade. May either be absolute path or relative to the upgrade configuration file. Either forwards or back slashes may be used as the path delimiter.
Msg	string	Text message displayed in progress dialog while script is active. Defaults to “Upgrading Database Schema to Version nnn”.
BackupDatabase	yes/no	If present and set to “yes” then a database backup in gbak format is made before the upgrade is performed. The backup file is located in the same directory as the database file and is given the same name as the database file with the extension replaced with “.nnn.gbak”. Where “nnn” is the current schema version number (i.e. prior to running the upgrade script).
<Parameter Name>	string	Name and optional path to binary data file. May either be absolute path or relative to the upgrade configuration file. Either forwards or back slashes may be used as the path delimiter.

For example:

[Version.002]

Msg = Upgrading to Version 2

BackupDatabase = yes

Upgrade = patches/02-patch.sql

mugshot = images/man.png.gz

Note that in the above, “mugshot” is intended to be used to resolve an Update, Insert or Delete query parameter in the 02-patch.sql file. E.g.

```
Update EMPLOYEE Set Photo =:MUGSHOT Where Emp_no = 2;
```

This is only applicable to BLOB columns and the above is interpreted as update the EMPLOYEE table where the Emp_no is “2” and set the value of the Photo column to the binary data contained in the file “images/man.png.gz”. The “.gz” extension is recognised as a gzip compressed file and decompressed before updating the table.

When the current database schema is more than one version number less than that required, the upgrade rules are applied iteratively to upgrade the database to the required schema version.

11.2 Local EmployeeDB Example

The purpose of this example is to demonstrate the use of the TIBLocalDBSupport component. This component is used with a TIBDatabase when the database is accessed using the Firebird Embedded Server. TIBLocalDBSupport takes care of checking the environment and setting up FIREBIRD environment variables and DB parameters. It also supports initialisation of the local database from an archive in gbak format, plus save and restore of the local database. It can also run SQL scripts to upgrade the database schema when a new software version is released.

The example can be found under: `ibx/examples/local-employeeedb/project1.lpi`

See also [console mode](#).

Before compiling and running the example, the Firebird embedded server must be installed. The Chapter 13 of the Firebird Pascal API Guide for deployment guidelines for the embedded server.

11.2.1 Running the application

The example should just compile and run. An archive of the Firebird example employee database is provided with the example. This will be used to create the initial database. It should then be automatically upgraded to “version 2” using the scripts provided in the “patches” directory. (see also the file `upgrade.conf`).

Note that you will not be prompted for a username/password. The embedded server uses normal file permissions to control access. Otherwise you can edit the employee database as in the client/server version.

The local database will be created in:

- Linux: `$HOME/.MWA Software/employee.fdb`
- Windows: `<User Application Data Folder>\MWA Software\employee.fdb`

The File menu provides actions to save the current database to a gbak format archive, restore it again (replacing the current database) or to restore the database to its initial state.

11.2.2 Console Mode

A console mode version of the example application is also provided under `ibx/examples/local-employeeedb/ConsoleModeExample.lpi`.



This uses the `iblocalhongi` package. The `IBCMLocalDBSupport` unit is used to provide the `TIBCMLocalDBSupport` component.

The application is similar to the above and uses the same archive database and upgrade scripts. Instead of displaying the employee table, when run it will print out the first two rows.

Appendix A. The Legacy IBX Services Components

This appendix describes the legacy IBX Components. These may be found on the “Firebird Legacy Admin” palette. They have been superseded by the re-architected Services components described in chapter 10. The legacy components are deprecated and should not be used in new applications.

A.1 Firebird Legacy Admin Component Overview

	TIBBackupService	The backup service supports database backup to gbak format archives. Both server side and client side backup file locations are supported.
	TIBRestoreService	The restore service supports database restore from gbak format archives. Both server side and client side backup file locations are supported.
	TIBConfigService	The configuration service allows database parameters to be modified, including whether the database is online, sync versus async writes, etc.
	TIBServerProperties	This service retrieves various server properties including the server version information, server parameters and the current status of database attachments.
	TIBLogService	This service supports the retrieval of the server log file contents.
	TIBStatisticalService	This service supports the retrieval of per database statistics.
	TIBSecurityService	This service supports management of the User Security Database.
	TIBValidationService	This service supports the invocation of various database repair actions, including validation and sweep. Limbo Transactions can also be resolved.
	TIBOnlineValidationService	This service was introduced for Firebird 3 and provides for a table level validation of a database. It implements consistency checks that do not require exclusive access to a database.

A.2 Common Service Properties

All Firebird Admin components derive from a common ancestor class and are used similarly. A common service editor is available at design time to set the login parameter defaults. The following properties are in common:

Active	Set to true to attach to the server and establish a connection with it. Set to false to terminate an active connection.
LoginPrompt	Set to true to enable use of the built-in login prompt dialog.
Params	Holds the login user name and password, as a list of keyword equals string (e.g. user_name=SYSDBA, password=masterkey). It is recommended that the password is not set at design time. A component editor is available to set each service's parameters.
Protocol	Determines the connection type (local, TCP,SPX or Named Pipe). Only the first two should be considered for use in current systems.
ServerName	The (domain) name of the server.
ServerVersionNo	An integer array [1..4] giving the Firebird Release number (elements 1..3) and the build no. (element 4).

The public property **ServiceIntf** exposes the `IServiceManager` interface used to communicate with the server. This interface is available (non-nil) when `Active` is true. It can be assigned between Firebird Admin components allowing them to share the same connection without having to separately log in for each separate service.

Note: setting active to false disconnects the connection and invalidates the shared interface.

From IBX 2.2 and Firebird 3 onwards, a Params line in the format

“expected_db=<databasename>”

is supported.

This is used when logging in with the service manager with user credentials that have to be authenticated in an alternative security database. The <databasename> is the name of a database on the server that uses the intended alternative security database.

The purpose of this is (e.g.) to perform a backup/restore for a database using an alternative security database. It is also needed for accessing database statistics or Limbo Transaction recovery.

A.3 The Backup Service

The backup service supports database backup to gbak format archives. Both server side and client side backup file locations are supported. Before the backup is started, the common properties must be set plus the following:

BackupFile	Server Side Backups only: This is a list full pathnames to one or more backup files on the server. When more than one is specified, all but the last should be followed by “=nnn” where nnn is the maximum length in bytes for the file.
BackupFileLocation	ServerSide or ClientSide. This determines whether the backup is to a file located on the server side or on the client side of the connection.
BlockingFactor	See gbak documentation for non-zero values (probably obsolescent)
DatabaseName	Alias of or full pathname for database on the server.
Options	See gbak documentation for interpretation of each option.
Verbose	Server Side Backups only: if true then additional text messages are generated.
StatisticsRequested	In verbose mode additional statistics are provided with output: <ul style="list-style-type: none"> • Total Time • Time Delta • Page Reads • PageWrites

A.3.1 Server Side Backup

The following code illustrates how a server side backup is performed after the above properties have been set:

```

IBBackupService1.Active := true;
IBBackupService1.ServiceStart;
while not IBBackupService1.Eof do
  writeln(IBBackupService1.GetNextLine);
  Application.ProcessMessages
IBBackupService1.Active := false; {only if you no longer need the connection}

```

Once the service has been started, running the service until completion is a simple loop checking for “EOF”, while calling the GetNextLine method. This returns lines of text from the server (most relevant in verbose mode). In this example, they are written to stdout.

A.3.2 Client Side Backup

The following code illustrates how a client side backup is performed after the above properties have been set:

```
var bakfile: TFileStream;
begin
  bakfile := TFileStream.Create('<path to backup file>',fmCreate);
  try
    IBBackupService1.Active := true;
    IBBackupService1.ServiceStart;
    while not IBBackupService1.Eof do
      begin
        IBBackupService1.WriteNextChunk(bakfile);
        Application.ProcessMessages
      end;
    finally
      bakfile.Free;
    end;
end;
```

The above is very similar to server side case, except that the service user has to provide a TStream (in the above TFileStream) as the destination of the backup archive. Instead of looking on GetNextLine, a client side backup loops on WriteNextChunk.

A.4 The Restore Service

The Restore service supports database restore from gbak format archives. Both server side and client side backup file locations are supported. Before the restore is started, the common properties must be set plus the following:

BackupFile	Server Side Restores only: This is a list full pathnames to one or more backup files on the server. When more than one is provided, these are read in the same order that the are defined
BackupFileLocation	ServerSide or ClientSide. This determines whether the restore is from a file located on the server side or on the client side of the connection.
DatabaseName	A list of Aliases of or full pathnames for database on the server.
Options	See gbak documentation for interpretation of each option. This must include either CreateNewDB (default) or Replace, but not both.
PageBuffers	See gbak documentation
PageSize	See gbak documentation
Verbose	If true then additional text messages are generated.
StatisticsRequested	In verbose mode additional statistics are provided with output: <ul style="list-style-type: none"> • Total Time • Time Delta

- | | |
|--|--|
| | <ul style="list-style-type: none"> • Page Reads • PageWrites |
|--|--|

A.4.1 Server Side Restores

The following code illustrates how a server side restore is performed after the above properties have been set:

```
IBRestoreService1.Active := true;
IBRestoreService1.ServiceStart;
while not IBRestoreService1.Eof do
begin
  writeln(IBRestoreService1.GetNextLine);
  Application.ProcessMessages
end;
```

Once the service has been started, running the service until completion is a simple loop checking for “EOF”, while calling the GetNextLine method. This returns lines of text from the server (most relevant in verbose mode). In this example, they are written to stdout.

A.4.2 Client Side Restores

The following code illustrates how a client side restore is performed after the above properties have been set:

```
var bakfile: TFileStream;
    line: string;
begin
  bakfile := TFileStream.Create('<path to backup file>',fmOpenRead);
  try
    IBRestoreService1.Active := true;
    IBRestoreService1.ServiceStart;
    while not IBRestoreService1.Eof do
    begin
      IBRestoreService1.SendNextChunk(bakfile, line);
      if line <> '' then
        writeln(line);
      Application.ProcessMessages
    end;
  finally
    bakfile.Free;
  end;
end;
```

The above is very similar to server side case, except that the service user has to provide a TStream (in the above TFileStream) as the source of the backup archive. Instead of looking on GetNextLine, a client side backup loops on SendNextChunk. This both reads from the stream and may return a line of text when one is received from the server.

A.5 The Configuration Services

The TIBConfigService must also have its common properties set as described above. Otherwise it comprises a set of methods, each of which performs a specific action.

ShutdownDatabase	Puts the database into its shutdown state according to the selected options and within the given “wait” time (seconds). Once shutdown, only the SYSDBA user can log into the database.
BringDatabaseOnline	Puts the database into its online state (reverse of shutdown).
SetSweepInterval	Sets the automatic sweep interval
SetDBSqlDialect	Sets the default database SQL dialect (1 or 3)
SetPageBuffers	Set the default number of cache buffers to the specified number.
ActivateShadow	Activates a database “shadow file” See the Firebird Documentation for more information on database shadow files.
SetReserveSpace	Configure the database to fill data pages when inserting new records (true), or reserve 20% of each page for later record deltas (true)
SetAsyncMode	Toggles between async writes (true) and sync writes (false).
SetReadOnly	Sets read only or read/write mode.
SetNoLinger	Set the No Linger Flag on a database. This is a “one-shot” override. Once set, the server will close the database immediately the last attachment is gone, regardless of the LINGER setting in the database. The LINGER setting is retained and works normally the next time.

A.6 The Server Properties Service

This service retrieves various server properties including the server version information, server parameters and the current status of database attachments. The information returned is divided up into:

- Server Version Information
- Active Database Information, and
- Configuration Parameters

Each information set has a corresponding method to request the current information, which then sets the values of the linked property. The property may then be read to access the requested information. For example:

```
var i: integer;
begin
  with IBServerProperties1 do
  begin
    Active := true;
    FetchVersionInfo;
    writeln('Server Version = ' + VersionInfo.ServerVersion);
    writeln('Server Implementation = ' + VersionInfo.ServerImplementation);
    writeln('Service Version = ' + IntToStr(VersionInfo.ServiceVersion));
```

```

FetchDatabaseInfo;
writeln('No. of attachments = ' + IntToStr(DatabaseInfo.NoOfAttachments));
writeln('No. of databases = ' + IntToStr(DatabaseInfo.NoOfDatabases));
for i := 0 to DatabaseInfo.NoOfDatabases - 1 do
  writeln('DB Name = ' + DatabaseInfo.DbName[i]);

FetchConfigParams;
writeln('Base Location = ' + ConfigParams.BaseLocation);
writeln('Lock File Location = ' + ConfigParams.LockFileLocation);
writeln('Security Database Location = ' + ConfigParams.SecurityDatabaseLocation);
end;
end;

```

A.7 The Log Service

This is a simple service that may be used to retrieve the current server log file contents. For example:

```

with IBLogService1 do
begin
  Active := true;
  ServiceStart;
  while not Eof do
  begin
    writeln(GetNextLine);
    Application.ProcessMessages;
  end;
end;
end;

```

A.8 The Database Statistics Services

This service supports the retrieval of per database statistics as text data. The use of this service is very similar to the Log Service except that:

- The `DatabaseName` property must be set to alias or full path name on the server of the database for which the statistics are requested.
- The `Options` property must be set to identify which statistics are requested.

Otherwise, statistics retrieval is the same as for the log file. For example:

```

with IBStatisticalService1 do
begin
  DatabaseName := 'myDatabase';
  Options := [HeaderPages];
  Active := true;
  ServiceStart;
  while not Eof do
  begin
    writeln(GetNextLine);
    Application.ProcessMessages;
  end;
end;
end;

```

The above returns the Header Page statistics. The options available are:

HeaderPages	Request only the information in the database header page
-------------	--

DataPages	Request statistics for user data pages
IndexPages	Request statistics for user index pages
SystemRelations	Request statistics for system tables and indexes — in addition to user tables and indexes

A.9 The Security Service

This service supports management of the User Security Database. It supports:

- The listing of all User Names, and other user identification information
- Adding New Users
- Modifying Existing Users (including changing passwords)
- Deleting Users.
- From Firebird 2.5 onwards, display and management of the user Admin Role.

A.9.1 Listing all User Names

The `DisplayUsers` method is used to retrieve the list of user names and other user identification information to the `UserInfo` property. This information can then be displayed to the user. For example:

```
var i: integer;
begin
  with IBSecurityService1 do
  begin
    Active := true;
    DisplayUsers;
    for i := 0 to UserInfoCount - 1 do
    with UserInfo[i] do
    begin
      writeln('User ID = ',UserID);
      writeln('Group ID = ',GroupID);
      writeln('User Name = ',UserName);
      writeln('First Name = ', FirstName);
      writeln('Middle Name = ', MiddleName);
      writeln('Last Name = ', LastName);
      write('Admin Role = ');
      if AdminRole then writeln('true') else writeln('false');
    end;
  end;
end;
```

A.9.2 Adding a User

The `AddUser` method is used to add a user to the Security Database. The `TIBSecurityService` `UserName` and `Password` properties should be set before this method is called to set the user name and password, respectively. The complete set of properties that may be set are:

UserName	User (or Login) Name
Password	The user's password

FirstName	The user's first name
MiddleName	The user's middle name
LastName	The user's last name
UserID	The Unix UID
GroupID	The Unix GID
AdminRole	True if the user is granted the Admin Role, otherwise false.

The following illustrates the use of the AddUsers method:

```
with IBSecurityService1 do
begin
  Active := true;
  UserName := NewUserName;
  Password := NewPassword;
  AddUser;
end;
```

A.9.3 Updating User Details

The ModifyUser method is used to modify a users login details in the Security Database. The UserName property acts as the key identifying the user. The remaining properties listed above in 10.11.2 may be set as required to update the corresponding entry in the database. For example:

```
with IBSecurityService1 do
begin
  Active := true;
  UserName := 'SYSDBA';
  FirstName := 'Donald';
  LastName := 'Duck';
  ModifyUser;
end;
```

A.9.4 Deleting a User

The DeleteUser method is used to remove a users login details from the Security Database. The UserName property acts as the key identifying the user. For example:

```
with IBSecurityService1 do
begin
  Active := true;
  UserName := 'ALICE';
  DeleteUser;
end;
```

A.10 The Validation Service

The TIBValidationService supports the invocation of various database repair actions, including validation and sweep. Limbo Transactions can also be resolved. It is effectively two services in one. The first case is used to perform a variety of repair actions. The second is more specific to resolving Limbo Transactions. Exclusive access is required to the database in order to perform these validation activities.

A.10.1 Database Repair

The following Database Repair services are available and selected by the service's options property:

Title	Option	Description
List Limbo Transactions	LimboTransactions	Returns a text list of limbo transactions
Check Database	CheckDB	Request read-only validation of the database, without correcting any problem
Ignore all checksum errors	IgnoreChecksum	Refines database check
Kill Shadow Files	KillShadows	Remove references to unavailable shadow files
Mend Database	MendDB	Mark corrupted records as unavailable, so subsequent operations skip them
Sweep Database	SweepDB	Request database sweep to mark outdated records as free space;
Validate Database	ValidateDB	Locate and release pages that are allocated but unassigned to any data structures
Full Database Validation	ValidateFull	Check record and page structures, releasing unassigned record fragments. Use with Validate Database

For example:

```
with IBValidationService1 do
begin
  DatabaseName := 'MyDatabase';
  Options := [ValidateDB,ValidateFull];
  Active := true;
  ServiceStart;
  while not Eof do
  begin
    writeln(GetNextLine);
```

```

    Application.ProcessMessages;
end;
end;

```

11.2.3 Resolving Limbo Transactions

There are two steps to the resolution of limbo transactions. The first step retrieves a list of all limbo transactions. The second step commits or rolls back each transaction as required.

The `FetchLimboTransactionInfo` method is used to retrieve list of limbo transactions. After completion, the list may be found in the `LimboTransactionInfo` property. For example:

```

var i: integer;
begin
  with IBValidationService1 do
    begin
      Active := true;
      ServiceStart;
      FetchLimboTransactionInfo;
      for i := 0 to LimboTransactionInfoCount - 1 do
        with LimboTransactionInfo[i] do
          begin
            write('ID = ', ID);
            if MultiDatabase then
              write(', Multi DB')
            else
              write(', Single DB');
            write(', Host Site = ', HostSite);
            write(', Remote Site = ', RemoteSite);
            write(', Database Path = ', RemoteDatabasePath);
            write(', State = ', StateToStr(State));
            writeln(', Advise = ', AdviseToStr(Advise));
          end;
        end;
      end;
    end;
end;

```

where

```

function StateToStr(State: TTransactionState): string;
begin
  case State of
    LimboState:
      Result := 'Limbo';
    CommitState:
      Result := 'Commit';
    RollbackState:
      Result := 'Rollback';
  else
    Result := 'Unknown';
  end;
end;

function AdviseToStr(Advise: TTransactionAdvise): string;
begin
  case Advise of
    CommitAdvise:
      Result := 'Commit';
    RollbackAdvise:
      Result := 'Rollback';
  else
    Result := 'Unknown';
  end;
end;

```

This list identifies each limbo transaction and its current state, it also suggests an action (advises). The user can review the list and set the `TLimboTransactionInfo.Action` property to a desired outcome.

The limbo transactions may then be resolved by setting the `GlobalAction` property and then calling the `FixLimboTransactionErrors` method.

The `GlobalAction` determines how `FixLimboTransactionErrors` processes the limbo transactions and may be set to:

<code>CommitGlobal</code>	All limbo transactions are resolved by committing the transaction.
<code>RollbackGlobal</code>	All limbo transactions are resolved by rolling back the transaction.
<code>RecoverTwoPhaseGlobal</code>	All limbo transactions are resolved by performing a two phase commit of the transaction.
<code>NoGlobalAction</code>	Limbo transactions are resolved by either committing or rolling back the transaction, as specified by each limbo transaction's <code>Action</code> property.

For example:

```
with IBValidationService1 do
begin
  GlobalAction := NoGlobalAction
  FixLimboTransactionErrors;
  while not Eof do
  begin
    writeln(GetNextLine);
    Application.ProcessMessages;
  end;
end;
```

A.11 The Online Validation Service

Online Validation was introduced in Firebird 2.5 that allows some consistency checks to be performed without exclusive access to the database. It may:

- validate some (or all) user tables in a database.
- validate some (or all) indices

Other ODS checks, such as Header/PIP/TIP/Generators pages, are not performed by Online Validation. The `TIBOnlineValidationService` component is the IBX interface to online validation.

A.11.1 Properties

<code>IncludeTables</code>	This is a case sensitive regular expression selecting the tables to include in online validation. For example, to select a list of tables, separate the tables names with the ' ' character.
----------------------------	--

	Leave empty to include all tables.
ExcludeTables	This is a regular expression selecting the tables to exclude from online validation. Leave empty to exclude none.
IncludeIndexes	This is a regular expression selecting the indexes to include in online validation. Leave empty to include all indexes.
ExcludeIndexes	This is a regular expression selecting the indexes to exclude from online validation. Leave empty to exclude none.
LockTimeout	This is the lock timeout in seconds. default is 10 secs. 0 is no-wait, -1 is infinite wait.

A.11.2 Usage

For example:

```
with IBOnlineValidationService1 do
begin
  Active := true;
  StartService;
  while not Eof do
  begin
    writeln(GetNextLine);
    Application.ProcessMessages;
  end;
end;
```

Appendix B. IBX Buffer Management

In both Lazarus and Delphi, a TDataset derived object is used provide the data source for Data Aware Controls such as TDBGrid. TDataset itself is an abstract class that represents a database Table or, more generally, the results of a database query. Database drivers, such as IBX, override TDataset to create a concrete class (e.g. TIBQuery) for processing query results as a dataset.

B.1 TDataset

TDataset presents the query results as a matrix of rows and columns. Data is accessed by selecting a given row as the current row and then addressing the columns in that row by name or position.

Datasets can be read only or read/write. In the latter case, the current row can be selected for edit, modified and the edited row “posted” back to the underlying database replacing the previous version of the row. It is also possible to delete the current row and to insert/append new rows.

Semantically, “Append” always inserts a new row at the end of the rows returned by the query, while “Insert” inserts the row immediately before the current row.

Note: when a dataset is opened, the row order is that of the underlying table or query sort order. This may be the order determined by the primary key or the ORDER BY clause of an SQL statement. When using Insert/Append the new row’s primary key (or the current sort key) should be appropriate for the row’s insertion point otherwise the row will appear in a different relative position when the dataset is closed and re-opened. It is up to the user of a TDataset subclass to ensure that this is the case - if this is important.

In order to use TDataset it must be sub-classed by a database driver. Each subclass implements a TDataset for a given type of database. For example, TIBQuery is a TDataset subclass implemented by IBX for use with a Firebird Database. It is the responsibility of the subclass to perform buffer management.

B.1.1 TDataset Buffers

TDataset provides a “sliding window” on the underlying dataset, using a variable length array of “display buffers” in sequential order. The (TDataset) window size should be sufficient to show all rows in (e.g.) the visible portion of a TDBGrid. The window is initially positioned at the start of the dataset and contains the first n rows of the dataset. It can then be advanced forward until it reaches the end of the dataset. If the dataset is additionally opened in bi-directional mode (as opposed to uni-directional mode) then the window can also be moved backwards. Irrespective of the mode, the user can select any row within the window, by moving backwards or forwards.

The buffer pointers are themselves opaque pointers to “buffers”. TDataset does not know how each buffer is structured or how row data (the columns, etc.) are organised within a buffer. The database driver contains this information in its TDataSet subclass and implements methods that provide access to buffer data.

TDataset provides a number of properties relevant to the Buffer Pool:

- *RecordCount*: This is overridden in a subclass to return the current record count. Note that only when all rows have been read from the underlying dataset can this be assumed to

return the query row count. The property always returns -1 if not overridden by the subclass.

- *ActiveRecord* is the index of the display buffer that is the ActiveBuffer e.g. if TDataset.Delete is called then the dataset row deleted is the one currently in the ActiveBuffer.
- *CurrentRecord*: The current record is the index of the display buffer currently in use by the dataset. This can differ from the active record when the dataset performs operations involving other records. For example, when painting a data-aware grid, CurrentRecord cycles through all the visible records, while ActiveRecord remains constant.
- *RecNo*: This is the index of the CurrentRecord in the underlying dataset. It is allocated by the subclass and cannot be assumed to correspond with the relative order of the rows in a dataset – especially after insert/append/delete operations. When a given row is known to be associated with a specific RecNo, setting the value of RecNo will make this row the active record. i.e. it can be used to bookmark rows. The RecNo associated with a given record may change if a dataset is closed and reopened. The property always returns -1 if not overridden by the subclass.

B.1.2 Buffer Pool Initialisation

The TDataset protected methods SetBufListSize and AllocRecordBuffer are used for initialisation of the display buffer pool. Neither method is intended to be called by the user.

TDataset.SetBufListSize is called internally by TDataset to allocate the memory for an array of pointers to the row buffers. The abstract method TDataset. AllocRecordBuffer is then called from SetBufListSize to allocate the memory for each of the row buffers in turn. The number of row buffers needed is calculated by querying each of the dataset's data sources for the maximum number required.

SetBufListSize is called when the dataset is opened and whenever a data source changes. It is a virtual method allowing a subclass to get an early indication of the number of buffers required. AllocRecordBuffer is an empty sub and must be implemented by a subclass.

The number of buffers required is saved in the private var FBufferCount. This is readable by a subclass as the protected property BufferCount. The buffer pointers are saved in the private array (FBuffers) and indexed as 0..FBufferCount.

There is hence an extra buffer in the pool. This “extra” buffer is used to read in a row from the database driver and then is swapped with the buffer in the display slot. This avoids the risk of a row being displayed while it is being updated. Inserted rows are similarly handled.

B.1.3 Buffer Pool Destruction

When a dataset is closed, the display buffers are released. The protected virtual method FreeRecordBuffer is called so that the subclass can free a buffer allocated by AllocRecordBuffer.

B.1.4 Scrolling Through a Dataset

A subclass must override the GetRecord and InternalSetToRecord methods in order to support dataset scrolling.

A database driver is expected to maintain a cursor on the underlying dataset. Initially, the cursor is at BOF. The cursor is then advanced to retrieve the first row in the dataset and so on until all rows have been retrieved when the cursor is now at EOF.

InternalSetToRecord is called to set the dataset cursor to the CurrentRecord. GetRecord is then called to fill a display buffer with the dataset row that is the CurrentRecord, or the previous row, or the next row. Datasets may be scrolled either uni-directionally (top to bottom only) or bi-directionally. In the former case, InternalSetToRecord can only advance the cursor and GetRecord cannot return the previous row.

GetRecord is called to copy a dataset row into the indicated buffer. The row returned depends on the TGetMode parameter:

- gmCurrent: the current row associated with the cursor. The cursor is not changed.
- gmNext: the cursor is advanced and the new current row is returned.
- gmPrior: the cursor is move backwards one row and the new current row returned.

gmPrior is never used when the dataset is opened in uni-directional mode. In bi-directional mode, the database driver may have to implement an internal row cache if it is to satisfy gmPrior when the underlying cursor is uni-directional - as is typically the case.

GetRecord returns gmOK on success or gmBOF/gmEOF to indicate no more rows for calls to gmPrior/gmNext. It may return gmError if the DoCheck parameter is true and there is a problem accessing the database. Although the database driver may return an exception on error.

B.1.5 Row Editing

Only the active record can be modified and only after the user calling TDataset.Edit programatically or implicitly by editing a Data Aware control. When the active row is placed into edit mode, the database driver should make a copy of the current row contents. This is so it can be restored if TDataset.Cancel is called to cancel all changes. Otherwise, the modifications are saved to the underlying database when TDataset.Post is called.

B.1.6 Row Deletion

The Active Row is deleted and removed from the TDataset buffers when the Delete method is called. The database driver also removes it from the underlying database and any internal record cache when TDataset.InternalDelete is called.

B.1.7 Row Insert/Append

TDataset provides two public methods to support insert/append, these are TDataset.Insert and TDataset.Append. The former inserts a new row immediately before the active record, while the later scrolls the dataset to the end and inserts a new row after the last row in the dataset. The new row becomes the active record and is immediately editable. The new row is saved to the underlying dataset when TDataset.Post is called, or removed if TDataset.Cancel is called before it is saved.

However, TDataset does nothing to ensure that the new row is the correct relative row position as defined by the query sort order. The user is expected to ensure that the row's column values mean

that it is correctly positioned according to the underlying query's sort key. Otherwise, when the dataset is refreshed the new row may appear in a different relative position.

B.1.8 Accessing Fields

Terminology: TDataset refers to the individual columns as "fields". The column values of the active record are accessed and set as the values of the corresponding fields. An object of the TField class is used to both describe a given field and to provide access to the field data.

A TField may also be a "calculated field". The values of calculated fields are also held in the display buffer but are never written through to the underlying dataset.

Fields may be accessed by name or position and are associated with database columns by name,

TDataset provides two public virtual methods: GetFieldData and SetFieldData which are called to respectively copy the column value from the active record to the requested field and to update the column value in the active record with the value of the Field.

These methods must be overridden by the database driver as TDataset does not know how field data is stored in a display buffer,

B.1.9 Calculated Fields

Calculated fields represent an alternative to server side computed fields and are implemented client side.

Calculated fields are defined at design time using the dataset's field editor. Each has a name and type. When the buffer pool is initialised, space in each row buffer must also be allocated for each such field. The TDataSet event OnCalcFields is called whenever a row is read in or edited in order to set the field values. It is the user's responsibility to set the value of each calculated field in the current record when OnCalcFields is called.

B.1.10 Blob Support

TDataset provides only the stub method CreateBlobStream in order to create a blob stream object to read or write a blob field's value. Everything else is handled by the database driver and its implementation of GetFieldData and SetFieldData.

B.2 Legacy IBX

Up to and including release 2.6.0 IBX allocates individual buffers in response to a call to allocRecordBuffer and maintains a separate row cache in a single memory block. Buffers in the cache are indexed using a unique record number allocated to each dataset row.

IBX also provides a "Cached Updates" mode of use. When this mode is selected, instead of writing through changes to the database when the change is posted (or a delete called), the changes are held in a pending state and applied as a batch or rolled back in a single operation. This implies that the original copies of each updated row must also be held in a separate "pending" buffer block until the changes are applied or cancelled.

Legacy IBX has several issues with its buffer management strategy:

- There is an “in memory” copy from the buffer cache to a display buffer each time the display window changes. This is because the display buffers are separate from the buffer cache.
- Using a single memory block for the buffer cache means that the entire block has to be reallocated when it needs to grow. Large datasets become increasingly inefficient.
- Calculated fields are held in both the display buffers and the buffer cache even though they are always recalculated when copying from the cache.
- Buffer inserts are always placed at the end of the buffer cache resulting in mis-ordering.

B.3 IBX: Improved Buffer Management

IBX 2.6 introduces a new buffer management strategy aimed at avoiding the above issues.

B.3.1 The Display Buffer

The most important change is for the display buffer pointer to point to an internal structure rather than an actual buffer. This structure is defined as:

```
PDisplayBuffer = ^TDisplaybuffer;
TDisplayBuffer = record
    dbBookmarkFlag: TBookmarkFlag;
    dbBookmarkData: array [1..sizeof(TIBRecordNumber)] of Byte;
    dbBuffer: PByte;
    dbCalcFields: PByte;
end;
```

This structure is effectively an indirect pointer to the actual row buffer (dbBuffer) in the buffer cache. Instead of an in memory copy when GetRecord returns the requested row into the display buffer, the new implementation of GetRecord simply updates dbBuffer to point to the selected row cache buffer.

The new structure also allows for a separate buffer for calculated fields (dbCalcField). This allocated by AllocRecordBuffer and stays linked to the display buffer. This avoids wasted space by allocating space for calculated fields in every row cache buffer.

The other two fields are required for TDataset local use and allow it to set a bookmark flag to access bookmark data.

B.3.2 The Buffer Cache

Instead of a single memory block being used for the buffer cache, a doubly linked list of memory blocks is used, each containing one or more buffers. This allows the buffer cache to be extended without having to copy the current memory block to a new larger one.

One additional benefit is that it is now possible to allocate a small block for the initial allocation and then a larger block for each extension. This allows for a sensible default initial allocation for efficient memory use for small datasets whilst a larger extension allocation optimises large datasets.

The above results in a more complicated structure for the buffer cache. However, access has been carefully optimised to recognise that most references are to the current, next or previous buffer. Random access is achieved by “walking” the buffer blocks and to find the block containing the required buffer and then direct access to the array of buffers in the block.

Row deletion is handled by marking a buffer as containing a deleted row. It can then be skipped by next and previous operations. It retains its record number thus not affecting random access times.

Insertions are permitted and implemented by permitting out of sequence next and previous operations. This ensures that inserted rows no longer “jump” to the end of the dataset when they scroll out of the current window.

B.4 Implementation

The new buffer management strategy is implemented as a set of helper classes rather than as part of TCustomIBDataset – which was the previous strategy. This should result in a clearer and more maintainable implementation.

It also allows for a straightforward implementation of the different buffer managers that IBX uses i.e.

- uni-directional
- bi-directional, and
- cached updates.

Each depend on a common base class and helper classes with the differences found in separate subclasses. Again, the result should result in a clearer and more maintainable implementation. The Buffer Managers are instantiated as COM interfaces.

The opportunity has also been taken to optimise the transfer of columns values to and from Firebird database buffers and, in particular, for Refresh, Update and Insert Operations. In this case, Legacy IBX matched SQL parameter names to field names every time such an operation was performed. In the new implementation, the names are matched once, on first use, and column numbers are used thereafter.

The Buffer Management Classes are:

• TIBSelectCursor	This is the base class for all IBX Buffer Managers. It provides all common functions. It also includes the logic for transferring column values to and from Firebird row buffers.
• TIBEditableCursor	This subclasses TIBSelectCursor and adds Update/Insert/Delete functionality.
• TIBUniDirectionalCursor	This subclasses TIBSelectCursor and implements a uni-directional buffer manager.
• TIBBiDirectionalCursor	This subclasses TIBSelectCursor and implements a bi-directional buffer manager.

The common functions for the Cached Updates Buffer Management are also implemented by `TIBEditableCursor`, while specific variations for uni and bi-directional buffer management are implemented by the respective buffer managers. “Cached updates” is selected when the buffer manager is created.

The most important feature of cached updates is in the way copies of a row are saved when the row is put into edit mode.

Without cached updates, a single “Old Buffer” is used to hold a copy of the edited row. This can be discarded when the row changes are posted to the dataset – or the edits cancelled. When updates are cached, a separate buffer pool is used to hold “old” copies of all edited rows for use if updates are cancelled. They can only be discarded after updates are applied. This buffer pool can be “walked” in reverse order when applying the updates and walked forward when cancelled updates allowing for efficient application of cached updates.

The buffer managers use a set of helper classes used to implement the buffer pools. These are:

<ul style="list-style-type: none"> • <code>TIBSimpleBufferPool</code> 	<p>This is the base class for the buffer pools. It implements a multi-block buffer pool where each block contains an array of one or more buffers. Each buffer is given a unique sequential record number that may be used for random access to the buffer.</p>
<ul style="list-style-type: none"> • <code>TIBBufferPool</code> 	<p>This is a subclass of <code>TIBSimpleBufferPool</code> and extends it to support buffer deletion and insertion.</p>
<ul style="list-style-type: none"> • <code>TIBOldBufferPool</code> 	<p>This is a subclass of <code>TIBSimpleBufferPool</code> and extends it to provide a pool of buffers used to hold old row copies in support of cached updates.</p>